

Approval body for construction products  
and types of construction

Bautechnisches Prüfamt

An institution established by the Federal and  
Laender Governments



## European Technical Assessment

ETA-11/0008  
of 28 April 2016

English translation prepared by DIBt - Original version in German language

### General Part

Technical Assessment Body issuing the  
European Technical Assessment:

Deutsches Institut für Bautechnik

Trade name of the construction product

Mungo MQL Universal Frame Plug

Product family  
to which the construction product belongs

Plastic anchor for multiple use in concrete and masonry  
for non-structural applications

Manufacturer

Mungo Befestigungstechnik AG  
Bornfeldstrasse 2  
4603 OLTEN  
SCHWEIZ

Manufacturing plant

Herstellwerk 1 - 6  
manufacturing plant 1 - 6

This European Technical Assessment  
contains

16 pages including 3 annexes which form an integral part  
of this assessment

This European Technical Assessment is  
issued in accordance with Regulation (EU)  
No 305/2011, on the basis of

Guideline for European technical approval of "Plastic  
Anchors for Multiple Use in Concrete and Masonry for  
non-structural Applications" ETAG 020 Part 1: "General",  
edition March 2012,  
used as European Assessment Document (EAD)  
according to Article 66 Paragraph 3 of Regulation (EU)  
No 305/2011.

**European Technical Assessment**

**ETA-11/0008**

English translation prepared by DIBt

Page 2 of 16 | 28 April 2016

The European Technical Assessment is issued by the Technical Assessment Body in its official language. Translations of this European Technical Assessment in other languages shall fully correspond to the original issued document and shall be identified as such.

Communication of this European Technical Assessment, including transmission by electronic means, shall be in full. However, partial reproduction may only be made with the written consent of the issuing Technical Assessment Body. Any partial reproduction shall be identified as such.

This European Technical Assessment may be withdrawn by the issuing Technical Assessment Body, in particular pursuant to information by the Commission in accordance with Article 25(3) of Regulation (EU) No 305/2011.

**Specific part**

**1 Technical description of the product**

The universal frame plug Mungo MQL is a plastic anchor consisting of a sleeve made of polyamide and an accompanying specific screw of galvanised steel or of stainless steel.

The plastic sleeve is expanded by screwing in the specific screw which presses the sleeve against the wall of the drilled hole.

The product description is given in Annex A.

**2 Specification of the intended use in accordance with the applicable European Assessment Document**

The performances given in Section 3 are only valid if the anchor is used in compliance with the specifications and conditions given in Annex B.

The verifications and assessment methods on which this ETA is based lead to the assumption of a working life of the anchor of at least 50 years. The indications given on the working life cannot be interpreted as a guarantee given by the producer, but are to be regarded only as a means for choosing the right products in relation to the expected economically reasonable working life of the works.

**3 Performance of the product and references to the methods used for its assessment**

**3.1 Mechanical resistance and stability (BWR 1)**

The essential characteristics regarding mechanical resistance and stability are included under the Basic Works Requirement Safety in use.

**3.2 Safety in case of fire (BWR 2)**

Essential characteristic	Performance
Reaction to fire	Anchorage satisfy requirements for Class A 1
Resistance to fire	No performance assessed

**3.3 Hygiene, health and the environment (BWR 3)**

Regarding dangerous substances there may be requirements (e.g. transposed European legislation and national laws, regulations and administrative provisions) applicable to the products falling within the scope of this European Technical Assessment. In order to meet the provisions of Regulation (EU) No 305/2011, these requirements need also to be complied with, when and where they apply.

**3.4 Safety and accessibility in use (BWR 4)**

Essential characteristic	Performance
Characteristic resistance for tension and shear loads	See Annex C 1 – C 4
Characteristic resistance for bending moments	See Annex C 1
Displacements under shear and tension loads	See Annex C 1
Anchor distances and dimensions of members	See Annex B 2, B 3

**3.5 Sustainable use of natural resources (BWR 7)**

For the sustainable use of natural resources no performance was determined for this product.

**4 Assessment and verification of constancy of performance (AVCP) system applied, with reference to its legal base**

In accordance with guideline for European technical approval ETAG 020, March 2012 used as European Assessment Document (EAD) according to Article 66 Paragraph 3 of Regulation (EU) No 305/2011 the applicable European legal act is: 97/463/EC.

The system to be applied is: 2+

**5 Technical details necessary for the implementation of the AVCP system, as provided for in the applicable EAD**

Technical details necessary for the implementation of the AVCP system are laid down in the control plan deposited with Deutsches Institut für Bautechnik.

Issued in Berlin on 28 April 2016 by Deutsches Institut für Bautechnik

Andreas Kummerow  
p. p. Head of Department

*beglaubigt:*  
Ziegler

Installed condition for MQL 10

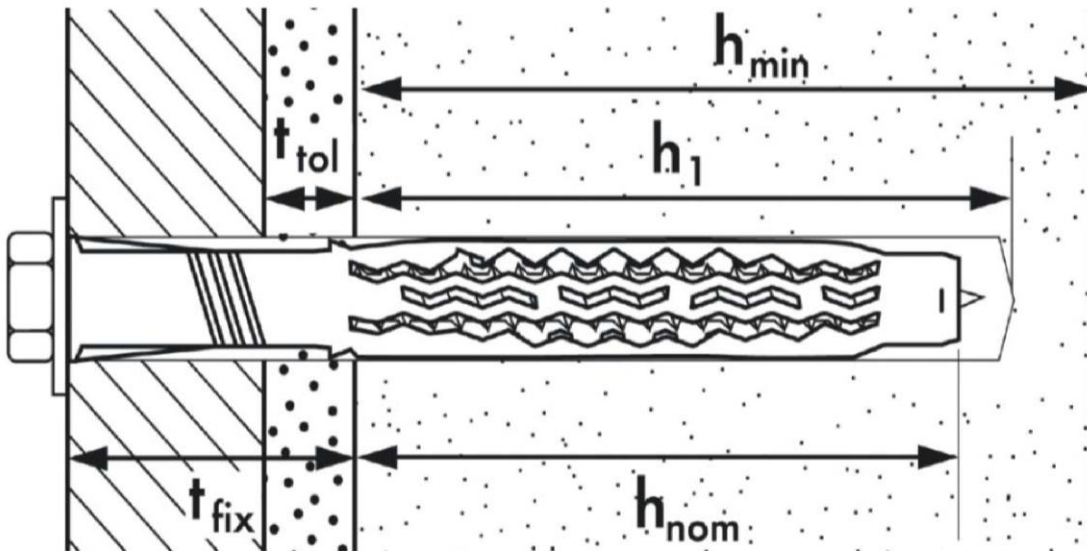

Legend

- $h_{min}$  = minimum thickness of structural part
- $h_1$  = depth of drilled hole to deepest point
- $t_{tol}$  = thickness of equalizing layer or non-load-bearing coating (non-structural layer)
- $t_{fix}$  = thickness of fixture (including non-load-bearing coating)
- $h_{nom}$  = overall anchor embedment depth in the base material

Mungo MQL Universal Frame Plug

Product description  
Installed condition

Annex A 1

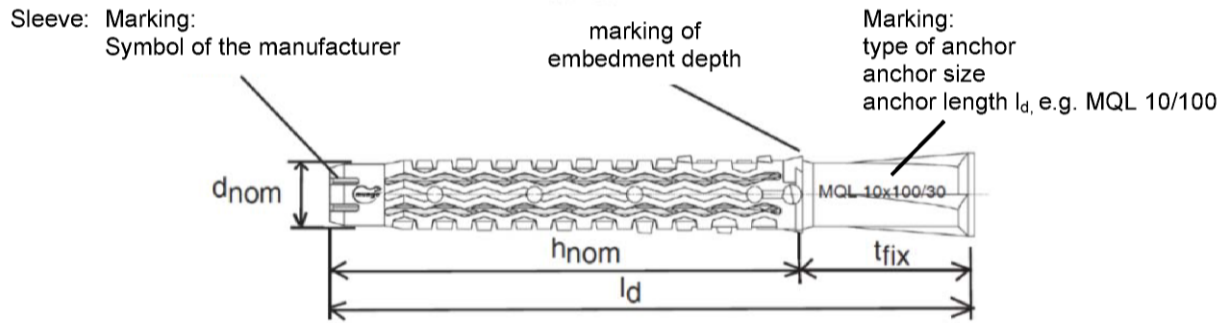

Version with broad collar:



Special screws:

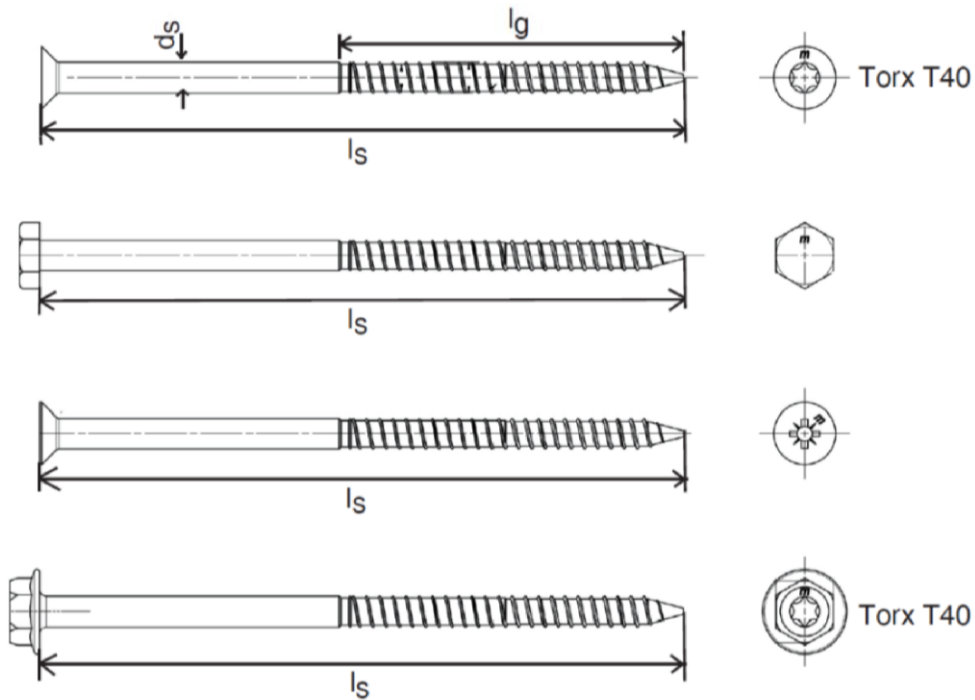

Mungo MQL Universal Frame Plug

Product description  
Anchor types and special screws

Annex A 2

**Table A1: Dimensions**

Anchor type	Plastic sleeve							Special screw <sup>2)</sup>		
	$h_{nom}$ [mm]	$d_{nom}$ [mm]	$t_{fix,min}$ [mm]	$t_{fix,max}$ [mm]	$l_d$ [mm]	$d_{kd}$ [mm]	$d_k$ [mm]	$d_s$ [mm]	$l_G$ [mm]	$l_{S,min}$ [mm]
<b>MQL 10<sup>1)</sup></b>	70	10	10	330	80 - 400	2	18	7	77	85

<sup>1)</sup> For description of the anchor the length of the plastic sleeve  $l_d$  is indicated additionally, e.g. for  $l_d=140$  mm: anchor MQL 10/ 140

<sup>2)</sup> The screw length  $l_s$  is 5 mm larger than the length of the plastic sleeve  $l_s$ , so the screw penetrates the appropriate plastic sleeve correctly.

**Table A2: Materials**

Name	Material
Plastic sleeve	Polyamide, PA6 colour orange
Special screw	steel 6.8, zinc plated $\geq 5\mu\text{m}$ acc. to EN ISO 4042:2001-01 blue passivated
	stainless steel A4 according to EN 10088-3:2014 material number 1.4401, 1.4301, 1.4571

**Mungo MQL Universal Frame Plug**

**Product description**  
Dimensions and materials

**Annex A 3**

### Specifications of intended use

#### Anchorage subject to:

- Static and quasi-static loads
- Multiple fixing of non-structural applications

**Table B1: Application categories in terms of base material and temperature range**

Application categories		See Annex	Anchor type MQL 10
<b>Base material</b> <sup>3)</sup>			
<b>a</b>	Reinforced or unreinforced normal weight concrete <sup>3)</sup> with strength classes $\geq$ C12/15 acc. to EN 206-1:2014	C 1	✓
<b>b</b>	Solid brick masonry <sup>1)2)3)</sup>	C 2	✓
<b>c</b>	Hollow brick masonry <sup>2)3)</sup>	C 3 + C 4	✓
<b>d</b>	Autoclaved aerated concrete	-	-
<b>Temperature range</b>			
<b>Tb</b>	min T = -20°C to +80°C (maximum short term temperature +80°C and maximum long term temperature +50°C)		✓
<sup>1)</sup> Note: The characteristic resistance is also valid for larger brick sizes and higher compressive strength. <sup>2)</sup> Clay bricks and calcium silicate bricks and mortar strength class $\geq$ M2,5 acc. to EN 998-2:2010 <sup>3)</sup> For other base materials of the use categories a, b or c the characteristic resistance of the anchor may be determined by job site tests according to ETAG 020, Annex B, Edition March 2012.			

#### Use conditions (environmental conditions):

- Structures subject to dry internal conditions (zinc coated steel, stainless steel).
- The specific screw made of galvanised steel may also be used in structures subject to external atmospheric exposure, if the area of the head of the screw is protected against moisture and driving rain after mounting of the fixing unit in this way, that intrusion of moisture into the anchor shaft is prevented. Therefore there shall be an external cladding or a ventilated rainscreen mounted in front of the head of the screw and the head of the screw itself shall be coated with a soft plastic, permanently elastic bitumen-oil-combination coating (e. g. undercoating or body cavity protection for cars).
- Structures subject to external atmospheric exposure (including industrial and marine environment) and to permanently damp internal condition, if no particular aggressive conditions exist (stainless steel).  
Note: Particular aggressive conditions are e.g. permanent, alternating immersion in seawater or the splash zone of seawater, chloride atmosphere of indoor swimming pools or atmosphere with extreme chemical pollution (e.g. in desulphurization plants or road tunnels where de-icing materials are used).

#### Design:

- The anchorages are to be designed in accordance with the ETAG 020, Annex C, Edition March 2012, under the responsibility of an engineer experienced in anchorages and masonry work.
- Verifiable calculation notes and drawings shall be prepared taking account of the loads to be anchored, the nature and strength of the base materials and the dimensions of the anchorage members as well as of the relevant tolerances. The position of the anchor is indicated on the design drawings.
- Fasteners are only to be used for multiple use for non-structural application according to ETAG 020, Edition March 2012.

#### Installation:

- Hole drilling by the drill modes according to Annex C1 - C4
- Anchor installation carried out by appropriately qualified personnel and under the supervision of the person responsible for technical matters of the site.
- Installation temperature from -20°C to +50°C
- Exposure to UV due to solar radiation of the anchor not protected  $\leq$  6 weeks

**Mungo MQL Universal Frame Plug**

**Intended use  
Specifications**

**Annex B 1**



**Table B2: Installation parameters**

Anchor type			MQL 10
Base material			Concrete solid brick hollow brick
Overall anchor embedment depth in the base material <sup>1)2)</sup>	$h_{nom}$	[mm]	$\geq 70$
Nominal drill hole diameter	$d_{nom}$	[mm]	10
Cutting diameter of drill bit	$d_{cut}$	[mm]	$\leq 10,45$
Depth of drill hole to deepest point <sup>1)</sup>	$h_1$	[mm]	80
Diameter of clearance hole in fixture	$d_f$	[mm]	10,5

<sup>1)</sup> see Annex A 1

<sup>2)</sup> In masonry made of hollow or perforated bricks the influence of  $h_{nom} > 70$  mm has to be determined by job site tests according to ETAG 020, Annex B.

**Table B3: Minimum thickness of member, edge distance and spacing in concrete**

Anchor type	Strength category	Minimum thickness of member	Characteristic edge distance	Characteristic spacing	Minimum edge distance	Minimum spacing
		$h_{min}$	$c_{cr,N}$	$s_{cr,N}$	$c_{min}$	$s_{min}$
		[mm]	[mm]	[mm]	[mm]	[mm]
MQL 10	C12/15	100	140	140	70	140
	$\geq C16/20$	100	100	100	50	100

Fixing points with spacing  $a \leq s_{cr,N}$  are considered as a group with a max. characteristic resistance  $N_{Rk,p}$  acc. to Table C3. For a spacing  $a > s_{cr,N}$  the anchors are considered as single anchors, each with a characteristic resistance  $N_{Rk,p}$  acc. to Table C3.

**Scheme of spacing and edge distances in concrete**

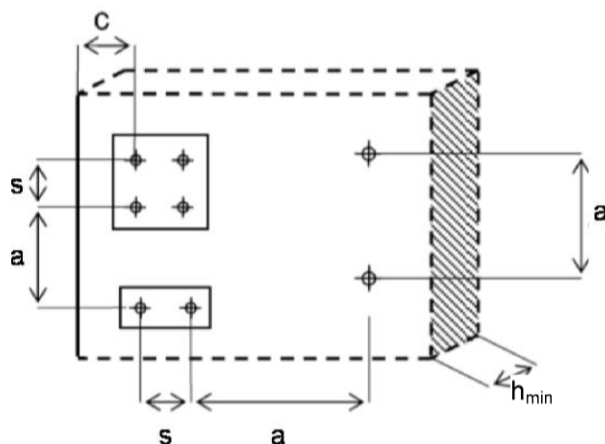

**Mungo MQL Universal Frame Plug**

**Intended use**  
Installation parameters, edge distance and spacing in concrete

**Annex B 2**

**Table B4: Minimale Bauteildicke, Randabstand und Achsabstand in Mauerwerk**

Base material	See Annex	Minimum member thickness	Minimum edge distance	Characteristic spacing	Minimum spacing		
					vertical to edge	parallel to edge	
					$h_{min}$	$c_{min}$	$a_{min}$
		[mm]	[mm]	[mm]	[mm]	[mm]	[mm]
Solid clay brick Mz 20/2,0 - 2DF	C 2	115	100	max (250 mm, $s_{1,min}$ , $s_{2,min}$ )	200	400	
Solid calcium silicate bricks KS 12/2,0 - 2DF	C 2	115					
Hollow clay brick HLz 12/1,2 - 10DF	C 3	240					
Ital. Hollow clay brick Mattone	C 3	240					
Calcium silicate hollow brick KSL 12/1,2-10DF	C 4	240					

**Scheme of spacing and edge distances in masonry**

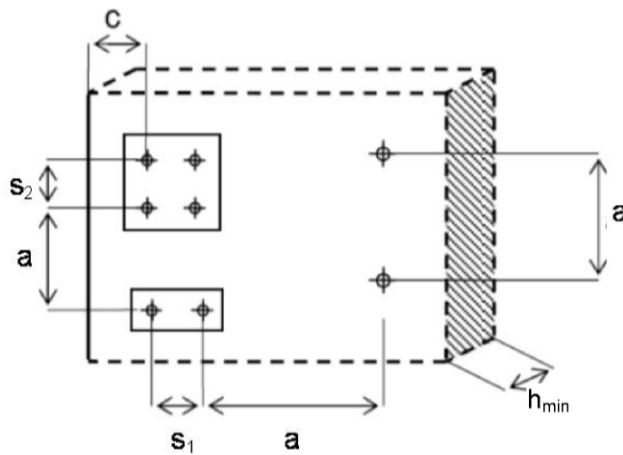

**Mungo MQL Universal Frame Plug**

**Intended use**  
Edge distance and spacing in masonry

**Annex B 3**

### Installation instructions in concrete and solid brick:

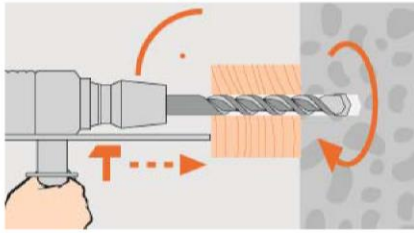

Drill the hole by **hammer drilling**.  
Chose drill diameter and drill hole depth according to Table B2.  
Temperature of base material  $\geq -20^{\circ}\text{C}$ .

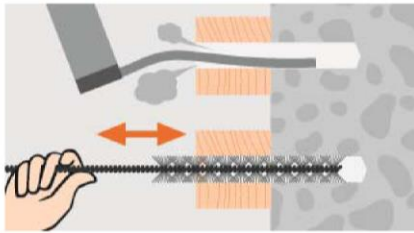

Pre-cleaning the drill hole with a brush, then hole-blowing with a pump.

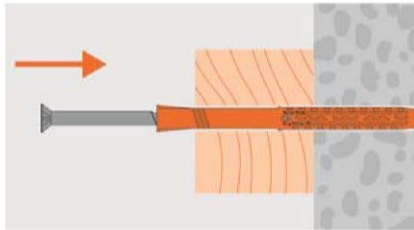

Setting the anchor with the preassembled fastener through the part to be fixed.

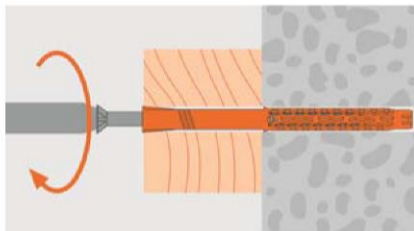

Push the anchor till the collar of the sleeve contacts the part to be fixed, then fix the part with screw.

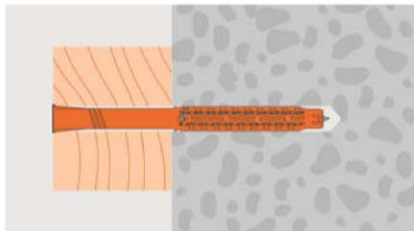

Tightening the fastener until sleeve collar contact.

#### Mungo MQL Universal Frame Plug

**Intended use**  
Installation instructions in concrete and solid brick

**Annex B 4**

### Installation instructions in hollow brick:

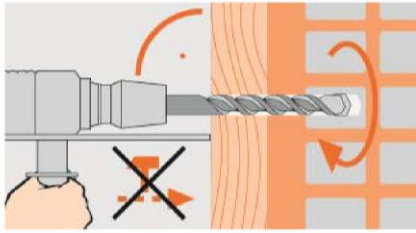

Drill the hole according to the method given in Table C6 and C7 by **rotary drilling** (without hammering) or **hammer drilling**.  
Chose drill hole diameter and drill hole depth according to Table B2.  
Temperature of base material  $\geq -20^{\circ}\text{C}$ .

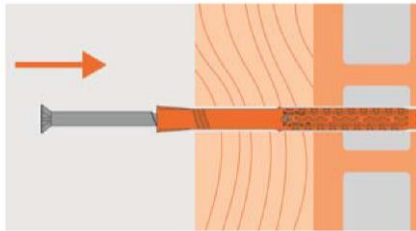

Setting the anchor with the preassembled fastener through the part to be fixed.

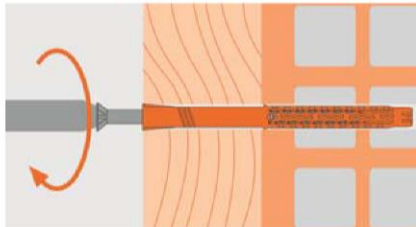

Push the anchor until the collar contacts the part to be fixed, then fix the part with screw.

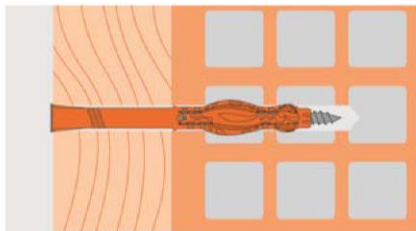

Tighten the fastener until sleeve collar contact.

**Mungo MQL Universal Frame Plug**

**Intended use**  
Installation instructions in hollow brick

**Annex B 5**

**Table C1: Characteristic bending resistance of the special screw**

Anchor type			MQL 10	
Steel type			Zinc plated steel	Stainless steel
Characteristic bending resistance	$M_{Rk,s}$	[Nm]	15,3	17,8
Partial safety factor	$\gamma_{Ms}$	<sup>1)</sup> [-]	1,25	1,56

<sup>1)</sup> In absence of other national regulations.

**Table C2: Characteristic resistance of the screw**

Anchor type			MQL 10	
Failure of expansion element (special screw)			Zinc plated steel	Stainless steel
Characteristic tension resistance	$N_{Rk,s}$	[kN]	17,0	19,8
Partial safety factor for $N_{Rk,s}$	$\gamma_{Ms}$	<sup>1)</sup> [-]	1,5	1,87
Characteristic shear resistance	$V_{Rk,s}$	[kN]	8,5	8,5
Partial safety factor for $V_{Rk,s}$	$\gamma_{Ms}$	<sup>1)</sup> [-]	1,25	1,56

<sup>1)</sup> In absence of other national regulations.

**Table C3: Characteristic resistance in in concrete (use category a)**

Anchor type			MQL 10	
Drilling method			Hammer drilling	
<b>Pullout failure (plastic sleeve)</b>				
<b>concrete C12/15</b>				
Characteristic resistance $50^{\circ}\text{C}^{1)}$ / $80^{\circ}\text{C}^{2)}$	$N_{Rk,p}$	[kN]	1,5	
<b>concrete <math>\geq</math> C16/20</b>				
Characteristic resistance $50^{\circ}\text{C}^{1)}$ / $80^{\circ}\text{C}^{2)}$	$N_{Rk,p}$	[kN]	2,5	

<sup>1)</sup> Maximum long term temperature

<sup>2)</sup> Maximum short term temperature

**Table C4: Displacements<sup>1)</sup> under tension and shear load in concrete and masonry**

Anchor type	Tension load			Shear load		
	$F$ <sup>2)</sup>	$\delta_{N0}$	$\delta_{N\infty}$	$F$ <sup>2)</sup>	$\delta_{V0}$	$\delta_{V\infty}$
	[kN]	[mm]	[mm]	[kN]	[mm]	[mm]
<b>MQL 10</b>	1,0	0,06	0,12	4,5	3,0 <sup>3)</sup>	4,5 <sup>3)</sup>

<sup>1)</sup> Valid for all temperature ranges.

<sup>2)</sup> Intermediate values by linear interpolation.

<sup>3)</sup> The displacements under shear load may increase in case of an annular gap in the fixture.

**Mungo MQL Universal Frame Plug**

**Performances**

Characteristic resistance in concrete, characteristic resistance of the screw displacements under tension and shear load in concrete and masonry

**Annex C 1**

**Table C5: Characteristic resistance for MQL 10 in solid masonry (use category b) –  
clay brick and calcium silicate brick**

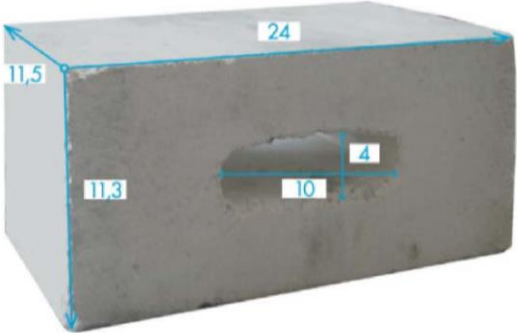
Base material	Geometry (format/ length/ width/ height) [mm]	Min. compressive strength $f_b$ [N/mm <sup>2</sup> ] bulk density $\geq \rho$ [kg/dm <sup>3</sup> ]	Drilling method <sup>1)</sup>	Characteristic resistance $F_{Rk}$ [kN]
				MQL 10
<b>Clay solid brick acc. to EN 771-1:2011 / DIN 105-100:2012-01</b>				
Mz 20/2,0  2DF: 240 115 113		10 / 2,0	H	2,0
		20 / 2,0	H	3,0
<b>Calcium silicate solid brick acc. to EN 771-2:2011 / DIN V 106:2005-10</b>				
KSV 12/2,0  2DF: 240 115 113		10 / 2,0	H	1,5
		20 / 2,0	H	2,5



<sup>1)</sup> H = Hammer drilling; R = Rotary drilling

**Mungo MQL Universal Frame Plug**

**Performances**  
Characteristic resistances in solid masonry

**Annex C 2**

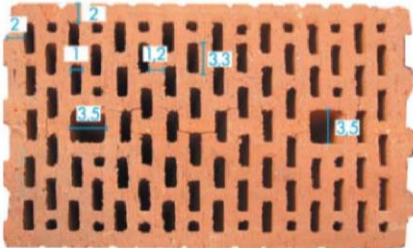
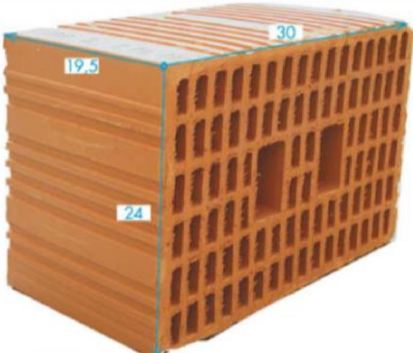
**Table C6: Characteristic resistance for MQL 10 in hollow or perforated masonry (use category c) – clay brick**

Base material	Geometry (format/ length/ width/ height) [mm]	Min. compressive strength $f_b$ [N/mm <sup>2</sup> ] bulk density $\geq \rho$ [kg/dm <sup>3</sup> ]	Drilling method <sup>1)</sup>	Characteristic resistance $F_{Rk}$ [kN]
				MQL 10
<b>Clay brick with perforation acc. to EN 771-1:2011 / DIN 105-100:2012-01</b>				
HLz 12/1,2	 10DF: 300 240 240	12 / 1,2	R	1,2 <sup>2)</sup>
			20 / 1,2	R
Ital. perforated brick Mattone	 300: 240 195	10 / 0,84	R	0,9 <sup>2)</sup>
				

<sup>1)</sup> H = Hammer drilling; R = Rotary drilling  
<sup>2)</sup> Shear load with lever arm is not allowed.

**Mungo MQL Universal Frame Plug**

**Performances**  
Characteristic resistances in hollow masonry

**Annex C 3**

**Table C7: Characteristic resistance for MQL 10 in hollow or perforated masonry (use category c) – calcium silicate brick**

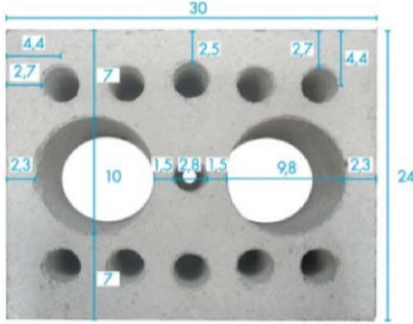
Base material	Geometry (format/ length/ width/ height) [mm]	Min. compressive strength $f_b$ [N/mm <sup>2</sup> ] bulk density $\geq \rho$ [kg/dm <sup>3</sup> ]	Drilling method <sup>1)</sup>	Characteristic resistance $F_{Rk}$ [kN]
				MQL 10
<b>Calcium silicate brick with perforation acc. to EN 771-2:2011 / DIN V 106:2005-10</b>				
KSL 12/1,4	300 240 115		H	1,2 <sup>2)</sup>
				

<sup>1)</sup> H = Hammer drilling; R = Rotary drilling  
<sup>2)</sup> Shear load with lever arm is not allowed.

**Mungo MQL Universal Frame Plug**

**Performances**  
Characteristic resistances in hollow masonry

**Annex C 4**