

COBRA®

# KATA LOG

[www.matekliku.cz](http://www.matekliku.cz)  
[www.cobrask.sk](http://www.cobrask.sk)

DESIGN  
KVALITA  
TRADICE

ČÍSLO

31  
32

# PRODUKTOVÝ KATALOG

31  
32

Vážení přátelé,

každý rok, když píšu úvodní stránku do nového katalogu, těším se na příští měsíce i na to, jak přijmete náš nový katalog a výrobky. Zároveň lehce rekapituluji předchozí rok a srovnávám ho s tím, co jsme plánovali před rokem. A musím říct - v loňském úvodníku jsem se těšila na úplně jiný svět, než kterým jsme museli projít. Takhle jsme třicáté narozeniny naší firmy neplánovali. Nechci ale, aby moje úvodní slovo vyznělo pesimisticky.

Naopak. Minulý rok byl pro mě důkazem, jak dobře Cobra funguje, jak skvělé mám kolegy, partnery i zákazníky. Díky vám jsme dokázali zvládnout komplikované časy, udržet obchod, distribuci i naši vzájemnou spolupráci na skvělé úrovni. Za společnou práci v loňském roce vám chci opravdu ze srdce poděkovat!

Ale - jsme již v roce 2021, přicházíme s novým katalogem, s novými plány a důvěrou v naše společné síly. Stále platí, že je naším cílem nabídnout tak široké portfolio produktů, aby každý zákazník našel ideální kování pro svůj dům, byt nebo projekt. Rádi vidíme naše kliky v designových interiérech i kancelářských projektech, stejně tak pohládíme naše kliky na horských chatách nebo zahradních domcích.

V katalogu 31/32 najdete nejen osvědčené modely, ale pochopitelně i řadu novinek. Designové trendy nás vedou k posílení minimalistických modelů dveřních kování. Zároveň jsme některé kolekce rozšířili o černé varianty, které jsou mezi zákazníky stále oblíbenější. V tmavých designech nově najdete nejen kliky, ale i samozavírače nebo třeba kování na sklo.

Pojďme dát příštím měsícům i celému roku pozitivní pointu (nikoliv pozitivní výsledky covid testů). Přeji vám všem zdraví, odolnost vůči všemu negativnímu a hlavně víru, že my, naše firmy i naše země dokážeme zvládnout ještě důležitější, než dříve!

Za tým Cobra

**Kristina Boda**  
generální ředitelka

*Kristina Boda*



































## OBSAH





Úvod .....	1
Obsah .....	2
Přehled kování a doplňků .....	4 - 9
Průvodce katalogem .....	10 - 19
Kliky Premium .....	20 - 23
Povrch IN - Nerez Classic .....	24 - 29
Povrch IN - Nerez Object .....	30 - 37
Povrch IN - Nerez Project .....	38 - 45
Povrch OCS - Chrom matný .....	46 - 53
Povrch OC - Chrom lesklý .....	54 - 57
Povrch ONS - Nikl matný .....	58 - 67
Povrch Černá / Titan .....	68 - 73
Povrch OCN - Chrom lesklý / nikl matný .....	74 - 77
Povrch OFS - Bronz česaný .....	78 - 83
Povrch OLV - Mosaz leštěná .....	84 - 87
Povrch OV - Staromosaz .....	88 - 89
Povrch K - kované a rustikální kování .....	90 - 97
BK - bezpečnostní a ochranné kování .....	98 - 105
S - sety .....	106 - 111
Povrch F1 - Stříbrný elox .....	112 - 115
Povrch F4 - Bronzový elox .....	116 - 119
Okenní kování .....	120 - 125
Madla / úchyty .....	126 - 135
Balkónové kliky .....	138
Kovaná posuvná klika Steinacht .....	139
Cylindrické vložky .....	140
Číslice a piktogramy / klepadla .....	144
Dorazy, stavěče, zarážky .....	146
Řetízky, kukátka .....	147
Držáky zábradlí .....	148
Drobný spojovací materiál .....	148
Krbové nářadí / Dětský program .....	149
Panikové kování .....	150
Rozety / montážní šablony .....	152
Prahové lišty .....	153
Samozavírače .....	154
Větrací mřížky .....	155
Vhozy na dopisy .....	155
Věšáky a konzole .....	156
Zadlabací zámky .....	158
Závěsy .....	159
Kování na sklo .....	164
Prodejní servis, záruky, montáž a údržba .....	168
Seznam kategorií .....	170





<p><b>ALEXIS</b></p>  <p>str. 60 <b>ONS</b></p>	<p><b>ALEXIS-R</b></p>  <p>str. 60 <b>ONS</b> str. 48 <b>OCS</b></p>	<p><b>ALT-WIEN</b></p>  <p>str. 92 <b>K</b> str. 80 <b>OFS</b></p> <p>str. 89 <b>OV</b> str. 86 <b>OLV</b> str. 60 <b>ONS</b> str. 48 <b>OCS</b> str. 56 <b>OC</b></p>	<p><b>Ochranný ALT-WIEN / ALT-WIEN+</b></p>  <p>str. 100 <b>OV</b> str. 100 <b>OLV</b> str. 100 <b>OFS</b></p>
<p><b>APHRODITÉ-S</b></p>  <p>str. 70 <b>Černá</b> str. 60 <b>ONS</b> str. 70 <b>Titan</b></p>	<p><b>ATHENA-S</b></p>  <p>str. 60 <b>ONS</b> str. 70 <b>Titan</b></p>	<p><b>ATLANTIS</b></p>  <p>str. 92 <b>K</b> str. 86 <b>OLV</b> str. 80 <b>OFS</b></p>	<p><b>ATLANTIS-R</b></p>  <p>str. 92 <b>K</b></p>
<p><b>BADEN</b></p>  <p>str. 92 <b>K</b></p>	<p><b>BADEN+</b></p>  <p>str. 92 <b>K</b></p>	<p><b>BADEN-S</b></p>  <p>str. 92 <b>K</b></p>	<p><b>BADEN-S+</b></p>  <p>str. 93 <b>K</b></p>
<p><b>BEATA-S</b></p>  <p>str. 60 <b>ONS</b></p>	<p><b>BERLIN</b></p>  <p>str. 93 <b>K</b></p>	<p><b>BIANCA-R</b></p>  <p>str. 26 <b>IN</b></p>	<p><b>BREMEN</b></p>  <p>str. 93 <b>K</b></p>
<p><b>BURG-R</b></p>  <p>str. 93 <b>K</b></p>	<p><b>C101+</b></p>  <p>str. 100 <b>ONS</b> str. 100 <b>OFS</b></p>	<p><b>C201</b></p>  <p>str. 100 <b>ONS</b> str. 100 <b>OFS</b></p>	<p><b>C301</b></p>  <p>str. 100 <b>ONS</b> str. 100 <b>OFS</b></p>
<p><b>C501+</b></p>  <p>str. 101 <b>IN</b></p>	<p><b>DEA</b></p>  <p>str. 80 <b>OFS</b></p>	<p><b>DEA-R</b></p>  <p>str. 80 <b>OFS</b></p>	<p><b>DENISA</b></p>  <p>str. 61 <b>ONS</b></p>
<p><b>DENISA-R</b></p>  <p>str. 61 <b>ONS</b></p>	<p><b>DIVA-R III</b></p>  <p>str. 32 <b>IN</b></p>	<p><b>ELEGANT</b></p>  <p>str. 93 <b>K</b> str. 80 <b>OFS</b></p> <p>str. 89 <b>OV</b> str. 86 <b>OLV</b> str. 61 <b>ONS</b> str. 48 <b>OCS</b> str. 56 <b>OC</b></p>	<p><b>Ochranný ELEGANT / ELEGANT+</b></p>  <p>str. 101 <b>OV</b> str. 101 <b>OLV</b> str. 101 <b>OFS</b></p>
<p><b>ELEMENT</b></p>  <p>str. 61 <b>ONS</b></p>	<p><b>ELEMENT-R</b></p>  <p>str. 61 <b>ONS</b></p>	<p><b>ELEMENT-R III</b></p>  <p>str. 32 <b>IN</b></p>	<p><b>ELSA-S</b></p>  <p>str. 61 <b>ONS</b> str. 48 <b>OCS</b></p>





<p><b>ESME-S</b></p>  <p>str.62 <b>ONS</b> str.48 <b>OCS</b></p>	<p><b>FAP</b></p>  <p>str.62 <b>ONS</b></p>	<p><b>FAP-R</b></p>  <p>str.62 <b>ONS</b></p>	<p><b>FLORENCE</b></p>  <p>str.80 <b>OFS</b></p>
<p><b>GABRI</b></p>  <p>str.76 <b>OCN</b></p>	<p><b>GABRI-R</b></p>  <p>str.76 <b>OCN</b></p>	<p><b>GABRI-S</b></p>  <p>str.70 <b>Černá</b> str.76 <b>OCN</b></p>	<p><b>GAIA-S</b></p>  <p>str.27 <b>IN</b> str.70 <b>Černá</b></p>
<p><b>GIUSSY</b></p>  <p>str.32 <b>IN</b></p>	<p><b>GIUSSY-R</b></p>  <p>str.26 <b>IN</b> str.70 <b>Černá</b> str.76 <b>OCN</b> str.81 <b>OFS</b></p>	<p><b>GIUSSY-R III</b></p>  <p>str.32 <b>IN</b></p>	<p><b>GIUSSY-S</b></p>  <p>str.26 <b>IN</b></p>
<p><b>GIUSSY-S III</b></p>  <p>str.32 <b>IN</b></p>	<p><b>HAMBURG</b></p>  <p>str.94 <b>K</b></p>	<p><b>HAMBURG-R</b></p>  <p>str.94 <b>K</b></p>	<p><b>HAMBURG-R+</b></p>  <p>str.94 <b>K</b></p>
<p><b>IKARUS</b></p>  <p>str.86 <b>OLV</b> str.81 <b>OFS</b></p>	<p><b>IMST+</b></p>  <p>str.94 <b>K</b></p>	<p><b>IMST-R</b></p>  <p>str.94 <b>K</b></p>	<p><b>INFINITY</b></p>  <p>str.21 <b>ONS</b> str.21 <b>Černá</b></p>
<p><b>INNSBRUCK</b></p>  <p>str.94 <b>K</b></p>	<p><b>INNSBRUCK-R</b></p>  <p>str.95 <b>K</b></p>	<p><b>IRIS-R III</b></p>  <p>str.33 <b>IN</b></p>	<p><b>IRIS-S III</b></p>  <p>str.33 <b>IN</b></p>
<p><b>JEROME-R</b></p>  <p>str.49 <b>OCS</b></p>	<p><b>KANELAZ 1745</b></p>  <p>str.22 <b>OS</b> str.22 <b>MB</b> str.22 <b>ONS</b></p>	<p><b>KANELAZ DVEŘNÍ KOULE 1745</b></p>  <p>str.22 <b>OS</b> str.22 <b>MB</b> str.22 <b>ONS</b></p>	<p><b>KANELAZ DVEŘNÍ MADLA 1745</b></p>  <p>str.23 <b>OS</b> str.23 <b>MB</b> str.23 <b>ONS</b></p>
<p><b>KOULE PEVNÁ BONN HR</b></p>  <p>str.96 <b>K</b></p>	<p><b>KOULE PEVNÁ LINZ</b></p>  <p>str.96 <b>K</b></p>	<p><b>KOULE PEVNÁ LUNA</b></p>  <p>str.37 <b>IN</b></p>	<p><b>KOULE PEVNÁ STAR</b></p>  <p>str.28 <b>IN</b> str.37 <b>IN</b></p>

<p><b>KOULE PEVNÁ STELLA</b></p>  <p>str.28 <b>IN</b> str.37 <b>IN</b></p>	<p><b>KOULE PEVNÁ VICTORY</b></p>  <p>str.77 <b>OCN</b> str.83 <b>OFS</b> str.66 <b>ONS</b> str.52 <b>OCS</b> str.72 <b>Černá</b></p>	<p><b>KRISTINA</b></p>  <p>str.86 <b>OLV</b> str.81 <b>OFS</b></p>	<p><b>KRISTINA-R</b></p>  <p>str.86 <b>OLV</b> str.81 <b>OFS</b></p>
<p><b>LAURA</b></p>  <p>str.81 <b>OFS</b> str.87 <b>OLV</b> str.62 <b>ONS</b> str.49 <b>OCS</b> str.56 <b>OC</b></p>	<p><b>LAURA-R</b></p>  <p>str.81 <b>OFS</b> str.87 <b>OLV</b> str.62 <b>ONS</b> str.49 <b>OCS</b> str.56 <b>OC</b></p>	<p><b>LINDA-S</b></p>  <p>str.70 <b>Černá</b></p>	<p><b>LOFT</b></p>  <p>str.33 <b>IN</b> str.41 <b>IN</b></p>
<p><b>LOFT KRÁTKÝ ŠTÍT</b></p>  <p>str.41 <b>IN</b></p>	<p><b>LOFT OVÁL</b></p>  <p>str.41 <b>IN</b></p>	<p><b>LOFT-R</b></p>  <p>str.41 <b>IN</b></p>	<p><b>LOFT-R III</b></p>  <p>str.33 <b>IN</b></p>
<p><b>LOFT-R OVÁL III</b></p>  <p>str.33 <b>IN</b></p>	<p><b>MARS-S+</b></p>  <p>str.101 <b>F1</b> str.101 <b>Černá</b></p>	<p><b>MEGA-S</b></p>  <p>str.49 <b>OCS</b></p>	<p><b>MILENA</b></p>  <p>str.82 <b>OFS</b> str.63 <b>ONS</b> str.49 <b>OCS</b></p>
<p><b>MILENA-R</b></p>  <p>str.63 <b>ONS</b> str.50 <b>OCS</b></p>	<p><b>MONET</b></p>  <p>str.118 <b>F4</b> str.114 <b>F1</b></p>	<p><b>MONET-R</b></p>  <p>str.118 <b>F4</b> str.114 <b>F1</b></p>	<p><b>MÜNSTER</b></p>  <p>str.87 <b>OLV</b> str.82 <b>OFS</b></p>
<p><b>NICOL-R</b></p>  <p>str.76 <b>OCN</b></p>	<p><b>NICOL-S</b></p>  <p>str.76 <b>OCN</b></p>	<p><b>NOVA-S</b></p>  <p>str.26 <b>IN</b></p>	<p><b>OMEGA-S</b></p>  <p>str.63 <b>ONS</b> str.71 <b>Černá</b></p>
<p><b>ORION</b></p>  <p>str.63 <b>ONS</b> str.50 <b>OCS</b></p>	<p><b>ORION-R</b></p>  <p>str.56 <b>OC</b> str.63 <b>ONS</b> str.50 <b>OCS</b></p>	<p><b>PAOLA</b></p>  <p>str.34 <b>IN</b></p>	<p><b>PAOLA-R III</b></p>  <p>str.34 <b>IN</b></p>
<p><b>PAVLA-H</b></p>  <p>str.34 <b>IN</b></p>	<p><b>PAVLA-R III</b></p>  <p>str.34 <b>IN</b></p>	<p><b>PAVLA-S III</b></p>  <p>str.34 <b>IN</b></p>	<p><b>PLAZA</b></p>  <p>str.34 <b>IN</b></p>

<p><b>PLAZA-H</b></p>  <p>str.35 <b>IN</b></p>	<p><b>PLAZA-R III</b></p>  <p>str.35 <b>IN</b></p>	<p><b>PLAZA-S III</b></p>  <p>str.35 <b>IN</b></p>	<p><b>PŘÍDAVNÁ ROZETA HRANATÁ</b></p>  <p>str.104 <b>OLV</b> str.104 <b>IN</b></p>
<p><b>PŘÍDAVNÁ ROZETA OVÁLNÁ</b></p>  <p>str.104 <b>OLV</b> str.104 <b>IN</b></p>	<p><b>PŘÍDAVNÁ ROZETA KULATÁ</b></p>  <p>str.104 <b>OLV</b> str.104 <b>IN</b></p>	<p><b>Q-ARTE</b></p>  <p>str.64 <b>ONS</b> str.50 <b>OCS</b></p>	<p><b>Q-ARTE-S</b></p>  <p>str.64 <b>ONS</b> str.50 <b>OCS</b></p>
<p><b>REGEN</b></p>  <p>str.95 <b>K</b></p>	<p><b>ROZETA TOWER</b></p>  <p>str.104 <b>F9</b> str.104 <b>F4</b> str.104 <b>F1</b></p>	<p><b>SALI</b></p>  <p>str.35 <b>IN</b></p>	<p><b>SALI-R</b></p>  <p>str.26 <b>IN</b></p>
<p><b>SALI-R III</b></p>  <p>str.35 <b>IN</b></p>	<p><b>SALI-S</b></p>  <p>str.26 <b>IN</b></p>	<p><b>SALI-S III</b></p>  <p>str.35 <b>IN</b></p>	<p><b>SALZBURG</b></p>  <p>str.95 <b>K</b></p>
<p><b>SALZBURG-S</b></p>  <p>str.95 <b>K</b></p>	<p><b>SHARON-R</b></p>  <p>str.77 <b>OCN</b></p>	<p><b>SINA</b></p>  <p>str.82 <b>OFS</b></p>	<p><b>SINA-R</b></p>  <p>str.82 <b>OFS</b></p>
<p><b>SLIM-2</b></p>  <p>str.101 <b>F9</b> str.101 <b>F4</b> str.101 <b>F1</b></p>	<p><b>SPECTRA</b></p>  <p>str.21 <b>Černá</b> str.21 <b>ONS</b></p>	<p><b>SPRING-S</b></p>  <p>str.64 <b>ONS</b></p>	<p><b>SVEVA</b></p>  <p>str.102 <b>OLV</b> str.102 <b>OFS</b> str.102 <b>ONS</b> str.102 <b>OC</b></p>
<p><b>SVEVA+</b></p>  <p>str.102 <b>OLV</b> str.102 <b>OFS</b> str.102 <b>ONS</b> str.102 <b>OC</b></p>	<p><b>TITAN</b></p>  <p>str.102 <b>OLV</b> str.102 <b>OFS</b> str.102 <b>ONS</b> str.102 <b>OC</b></p>	<p><b>TITAN+</b></p>  <p>str.102 <b>OLV</b> str.102 <b>OFS</b> str.102 <b>ONS</b> str.102 <b>OC</b></p>	<p><b>TOWER</b></p>  <p>str.102 <b>F9</b> str.102 <b>F4</b> str.102 <b>F1</b></p>
<p><b>TOWER+</b></p>  <p>str.103 <b>F9</b> str.103 <b>F4</b> str.103 <b>F1</b></p>	<p><b>TOWER-H</b></p>  <p>str.103 <b>F9</b> str.103 <b>F4</b> str.103 <b>F1</b></p>	<p><b>TOWER-H+</b></p>  <p>str.104 <b>F9</b> str.104 <b>F4</b> str.104 <b>F1</b></p>	<p><b>UFO</b></p>  <p>str.36 <b>IN</b> str.43 <b>IN</b></p>



<p><b>UFO KRÁTKÁ ŠTÍT</b></p>  <p>str. 43 <b>IN</b></p>	<p><b>UFO SLIM</b></p>  <p>str. 36 <b>IN</b></p>	<p><b>UFO OVÁL</b></p>  <p>str. 43 <b>IN</b></p>	<p><b>UFO-R</b></p>  <p>str. 27 <b>IN</b> str. 43 <b>IN</b></p>
<p><b>UFO-R III</b></p>  <p>str. 36 <b>IN</b></p>	<p><b>UFO-R OVÁL</b></p>  <p>str. 36 <b>IN</b></p>	<p><b>ULTIMA</b></p>  <p>str. 21 <b>ONS</b> str. 21 <b>Černá</b></p>	<p><b>UNIVERSAL</b></p>  <p>str. 118 <b>F4</b> str. 114 <b>F1</b></p>
<p><b>UNIVERSAL-R</b></p>  <p>str. 118 <b>F4</b> str. 114 <b>F1</b></p>	<p><b>VANDA-R</b></p>  <p>str. 77 <b>OCN</b></p>	<p><b>VEGA-S</b></p>  <p>str. 64 <b>ONS</b> str. 71 <b>Černá</b></p>	<p><b>VENEZIA</b></p>  <p>str. 82 <b>OFS</b> str. 95 <b>K</b></p>
<p><b>VENEZIA-R</b></p>  <p>str. 95 <b>K</b></p>	<p><b>VERA-S</b></p>  <p>str. 71 <b>Černá</b> str. 82 <b>OFS</b> str. 64 <b>ONS</b></p>	<p><b>VIENNA-R+</b></p>  <p>str. 96 <b>K</b></p>	<p><b>VISION</b></p>  <p>str. 36 <b>IN</b> str. 45 <b>IN</b></p>
<p><b>VISION KRÁTKÝ ŠTÍT</b></p>  <p>str. 45 <b>IN</b></p>	<p><b>VISION OVÁL</b></p>  <p>str. 45 <b>IN</b></p>	<p><b>VISION-R OVÁL</b></p>  <p>str. 36 <b>IN</b></p>	<p><b>VISION-R</b></p>  <p>str. 27 <b>IN</b> str. 45 <b>IN</b></p>
<p><b>VISION-R III</b></p>  <p>str. 71 <b>Černá</b> str. 37 <b>IN</b></p>	<p><b>VISION-R PLOCHÁ ROZETA</b></p>  <p>str. 27 <b>IN</b></p>	<p><b>VISION-S</b></p>  <p>str. 27 <b>IN</b></p>	<p><b>VISION-S III</b></p>  <p>str. 37 <b>IN</b></p>
<p><b>VISION-S PLOCHÁ ROZETA</b></p>  <p>str. 27 <b>IN</b></p>	<p><b>ZEUS</b></p>  <p>str. 64 <b>ONS</b></p>	<p><b>ZEUS-R III</b></p>  <p>str. 65 <b>ONS</b></p>	<p><b>ZOE-R</b></p>  <p>str. 71 <b>Černá</b> str. 83 <b>OFS</b> str. 65 <b>ONS</b></p>
<p><b>ZOE-R III</b></p>  <p>str. 37 <b>IN</b></p>	<p><b>865</b></p>  <p>str. 71 <b>Černá</b> str. 51 <b>OCS</b> str. 65 <b>ONS</b></p>	<p><b>1085</b></p>  <p>str. 89 <b>OV</b> str. 51 <b>OCS</b> str. 65 <b>ONS</b></p>	<p><b>1105</b></p>  <p>str. 56 <b>OC</b></p>

<p>1115</p>  <p>str.89 <b>OV</b> str.51 <b>OCS</b> str.65 <b>ONS</b></p>	<p>1145</p>  <p>str.51 <b>OCS</b> str.65 <b>ONS</b></p>	<p>1485</p>  <p>str.51 <b>OCS</b> str.57 <b>OC</b></p>	<p>1495</p>  <p>str.72 <b>Černá</b> str.66 <b>ONS</b> str.51 <b>OCS</b> str.57 <b>OC</b></p>
---	--	---	---

<p>1505</p>  <p>str.52 <b>OCS</b> str.57 <b>OC</b></p>	<p>1515</p>  <p>str.51 <b>OCS</b> str.57 <b>OC</b></p>	<p>1555</p>  <p>str.72 <b>Černá</b> str.66 <b>ONS</b> str.52 <b>OCS</b></p>
---	---	--

**PŘEHLED KOVÁNÍ  
A DOPLŇKŮ**

<p>OKENNÍ KOVÁNÍ</p>  <p>str.122</p>	<p>MADLA / ÚCHYTY</p>  <p>str.128</p>	<p>BALKÓNOVÉ KLIKY</p>  <p>str.138</p>
---	---	---

<p>KOVANÁ POSUVNÁ KLIKA STEINACHT</p>  <p>str.139</p>	<p>CYLINDRICKÉ VLOŽKY</p>  <p>str.140</p>	<p>ČÍSLICE A PIKTOGRAMY / KLEPADLA</p> <p>ab073</p> <p>str.144</p>	<p>DORAZY, STAVĚČE, ZARÁŽKY</p>  <p>str.146</p>
---	---	--	---

<p>ŘETÍZKY, KUKÁTKA</p>  <p>str.147</p>	<p>DRŽÁKY ZÁBRADLÍ</p>  <p>str.148</p>	<p>DROBNÝ SPOJOVACÍ MATERIÁL</p>  <p>str.148</p>	<p>KRBOVÉ NÁŘADÍ / DĚTSKÝ PROGRAM</p>  <p>str.149</p>
--	---	--	--

<p>PANIKOVÉ KOVÁNÍ</p>  <p>str.150</p>	<p>ROZETY / MONTÁŽNÍ ŠABLONY</p>  <p>str.152</p>	<p>PRÁHOVÉ LIŠTY</p>  <p>str.153</p>	<p>SAMOZAVÍRAČE</p>  <p>str.154</p>
---	---	--	--

<p>VĚTRACÍ MŘÍŽKY</p>  <p>str.155</p>	<p>VHOZY NA DOPISY</p>  <p>str.155</p>	<p>VĚŠÁKY A KONZOLE</p>  <p>str.156</p>	<p>ZADLABACÍ ZÁMKY</p>  <p>str.158</p>
--	---	---	---

















<p>ZÁVĚSY</p>  <p>str.159</p>	<p>KOVÁNÍ NA SKLO</p>  <p>str.164</p>
--	--

## Symbols / Symbols

 Objektové kování Hardware for object	 Kovová rozeta Metal rosette	 Ochranné kování Protective fitting
 Kuličkové ložisko Ball-bearing	 Bez výstupků Without pins	 Bezpečnostní certifikát 1. třída bezpečnosti dle ČSN EN 1906 Safety certificate - The first class of safety
 Protipožární Fireproof	 Plastová rozeta Plastic rosette	 Bezpečnostní certifikát 2. třída bezpečnosti dle ČSN EN 1906 Safety certificate - The second class of safety
 Kovová vratná pružina Metal spring	 Prověřený způsob uchycení Proven assembling	 Bezpečnostní certifikát 3. třída bezpečnosti dle ČSN EN 1906 Safety certificate - The third class of safety
 Fixační kovové výstupky Fixing metal pins	 100 tis. frekvence použití, certifikováno na minimální počet cyklů Frequency of use - min. 100 thousand	 Bezpečnostní certifikát 4. třída bezpečnosti dle ČSN EN 1906 Safety certificate - The fourth class of safety
 Venkovní použití Outdoor use	 200 tis. frekvence použití, certifikováno na minimální počet cyklů Frequency of use - min. 200 thousand	 BB - dózický klíč Standard keyhole
 Set, možnost sestavy vchodové, okenní, dveřní Set, possibility of set - entrance, window, door	 1 mil. frekvence použití, certifikováno na minimální počet cyklů Frequency of use - min. 1 milion	 Koule/klika Knob/handle
		 PZ - Cylindrická vložka Profile cylinder

## Tabulka povrchů kování

List of possible finishes for door handles

 Nerez Matt Stanielss steel	 Chrom lesk / Nikl mat Polished chrome / satin nickel	 Matná mosaz Matt brass	 Bronzový elox Brass elox
 Chrom matný Satin chrome	 Bronz česaný Brushed brass	 Matný bronz Matt bronze	 Černá Black
 Chrom lesklý Polished chrome	 Mosaz leštěná Polished brass	 Kované a rustikální Forged hardware	 Titan Titanium
 Nikl matný Satin nickel	 Staromosaz Old brass	 Stříbrný elox Silver elox	 Mosaz Antik Antique brass

Můžete investovat mnoho času i peněz do volby podlah, oken nebo třeba kuchyňské linky a bude to úplně v pořádku. Šperkem, který zvýrazní styl vaší domácnosti, se ale mohou stát právě kliky a kování na vašich dveřích. Nejde totiž jen o funkční prostředek k otevírání dveří - při správné volbě skutečně plní funkci estetického doplňku, kterého se každodenně dotýkáme, vnímáme ho, a který by měl respektovat osobitost a design našeho bytu či domu.

You can surely invest plenty of time and money in the right choice of floorboards, windows or even a kitchen line and it will be perfectly fine. However, the gem that may enhance your household style can simply be the right choice of door handles and fittings. It is not just functional device to open doors, but also - if appropriately selected - it can undoubtedly perform the function of an aesthetic accessory which we touch and perceive on daily basis. It should therefore respect the distinctiveness and the design of our flat or house.

# Zeus

název kliky / model

**200 tis.**

piktogramy vlastností dané kliky na straně 3 - SYMBOLY / pictograms of characteristics of a selected model shown on page 3 - SYMBOLS

piktogram tvaru zvolené vložky - kompletní seznam na straně 3 / Pictogram of a selected keyhole - complete list on page 3

ceny v českých korunách bez DPH a s 21% DPH / Prices in Czech crowns without VAT and with 21% VAT

výška štítu / length of plate

237

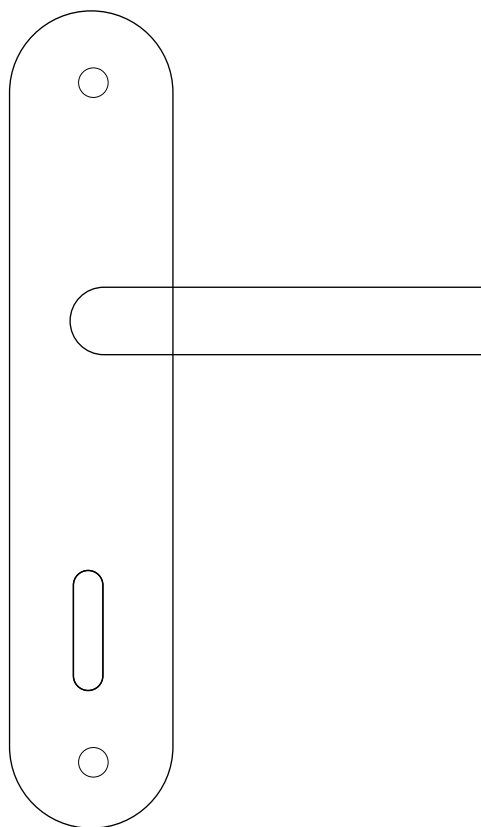

40 šířka štítu, rozety / width of plate, rosette

šířka kliky / width of handle 115

59 celková hloubka (štít včetně kliky) / total depth (including the handle)

	CZK	bez DPH	s DPH
BB/PZ		355,-	430,-
WC		455,-	550,-
PZ-LI/RE		500,-	605,-
	EUR	bez DPH	s DPH
BB/PZ		13,9	16,7
WC		17,8	21,4
PZ-LI/RE		19,6	23,5

ceny v eurech bez DPH a s 20% DPH / Prices in Euros without VAT and with 20% VAT



fotografie kliky v daném povrchu / picture of a chosen door handle in the given finish

**ONS**

piktogramy s možností povrchu této dané kliky - zkratky povrchů naleznete na straně 4 / pictograms of possible finishes for a chosen handle - complete list of finishes shown on page 4

- Výše DPH se řídí platnými předpisy pro danou zemi
- Products are listed with the current VAT of 21% in CZK and 20% in EUR and are subject to change. Current prices with VAT are available at [www.matekliku.cz](http://www.matekliku.cz)

## JAK VYBRAT TO SPRÁVNÉ KOVÁNÍ?

Nabídka dveřních kování, jednotlivých tvarů, kombinací a designů je tak široká, že na první pohled může být složité se v ní zorientovat. Rozhodnutí o designu záleží pouze na vás, my vám rádi pomůžeme vybrat to správné řešení z pohledu technických parametrů:

### 1. DRUH KOVÁNÍ

Jaký styl se více hodí na vaše dveře - rozetové nebo štítové kování?

**ROZETOVÉ** - skládá se ze dvou dílů - samostatné kliky a rozety pro zámek.

- Elegantní a moderní typ kování oblíbený zejména v moderních interiérech a kancelářích
- Vnitřní systém prošroubování zajišťuje dlouhou životnost kování, montážní šrouby jsou překryty rozetami, díky čemuž vypadá rozetové kování vždy elegantně
- Kromě designu samotné kliky rozhodujeme zpravidla i o tvaru rozety - mezi kulatou, oválnou a hranatou

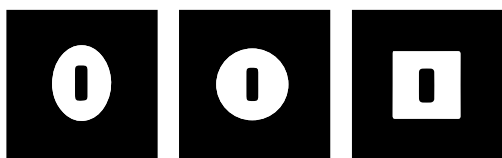

**ŠTÍTOVÉ** - jedná se o jednoduché dveřní kování, kde je otvor pro zámek i kliku zakrytý jedním štítem.

- Snadné na montáž pomocí viditelných vrutů
- Nejběžnější a nejdéle používaný typ kování, který najde své místo ve všech interiérech, od bytů po chaty a zahradní domky.

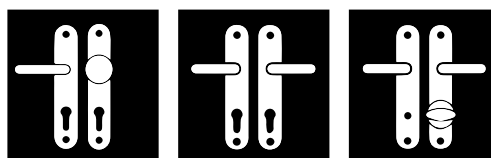

### 2. DRUH ZÁMKU

Varianta zámku a klíče pochopitelně odpovídá konkrétnímu umístění dveřního kování. V našem katalogu a eshopu se běžně setkáte s následujícími označeními:



**PZ** - zkratka pro klíč se zámekem, takzvanou „fabkou“



**BB** - součástí kování je otvor pro klasický dózický klíč.



**WC** - sada využívaná na toaletách a v koupelnách - z vnitřní strany dveří je pro zamčení opatřena WC klikkou, ze strany vnější je rozeta s drážkou, díky které lze v případě potřeby dveře odemknout z vnější strany použitím plochého předmětu.

### 3. KOMBINACE KOVÁNÍ

Ne všechny dveře vyžadují kliku. Jakou kombinaci dveřního kování opravdu potřebujete?



**Klika klika**



**Klika koule**

### 3. ORIENTACE KOVÁNÍ

Rozhodnutí, zda objednáte levou nebo pravou kliku, je jedna z mála věcí, které musíte stanovit samostatně a dobře. Pro rozhodnutí je jednoduchá poučka - pokud na kliku sáhnete pravou rukou, jedná se o kliku pravou. Stejně tak levou kliku budete vždy otvírat rukou levou. Pokud dokážete otvírat pravou rukou levou kliku, děláte to špatně nebo stojíte zády ke dveřím. Abychom dostáli instruktážním zásadám, raději ještě uvedeme upřesňující grafiky, které vám jistě pomohou nejlépe:

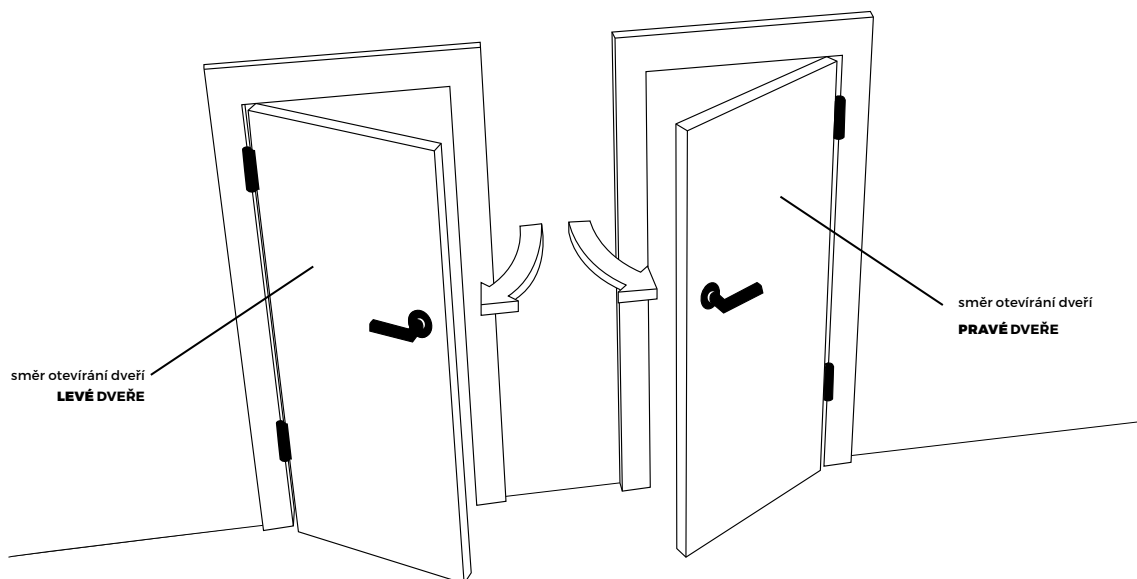

#### Co je to ROZTEČ štítového kování?

Jedná se o vzdálenost osy kliky a klíče vašich dveří. Tento údaj je zcela zásadní pro nákup správného štítového kování. Nejběžnější rozteče jsou 72 a 90mm, u bezpečnostního kování mohou být i 92mm.

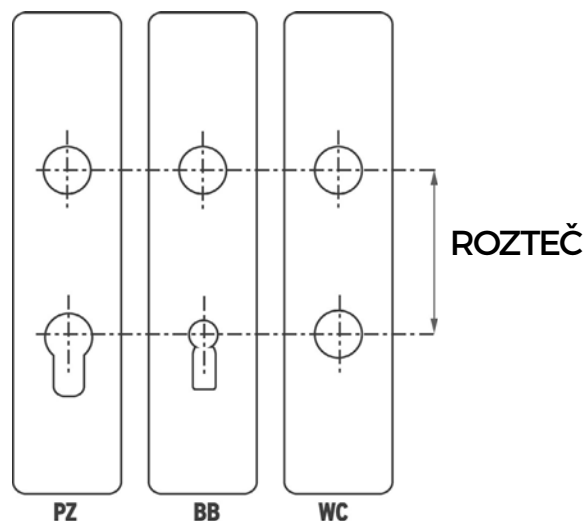

## HOW TO SELECT THE RIGHT FITTINGS?

The range of products offered – door fittings, individual shapes, combinations and designs - is so extensive that at first sight it may be very difficult for a customer to understand it. The decision regarding the design depends solely on you and we will be more than happy to help you finding the right solution in terms of technical parameters.:

### 1. TYPE OF FITTINGS

What type of door fittings is more suitable for your door – rosette or plate fittings?

**ROSETTE** - consists of two parts – separate handle and a rosette for lock.

- elegant and modern type of fitting popular especially in modern interiors and office buildings
- the inner system of screwing ensures a long lifetime of the fitting, fixing bolts are covered with rosettes thus making the rosette fittings look elegant at all times
- apart from the design of the handle itself we also think about the shape of rosette - round, oval or square

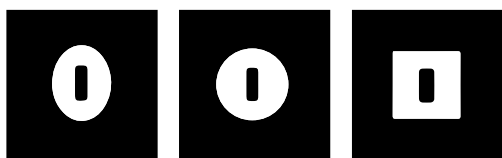

**PLATE** - it is a one-piece door fitting with a hole for a lock and a handle covered with one plate.

- easy to mount using visible bolts
- the most common and long-established type of fitting which will surely find its place in all types of interiors from flats to small huts and even garden sheds.

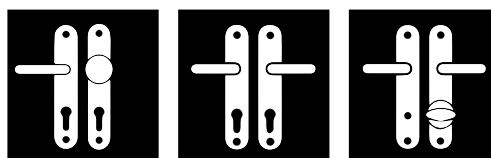

### 2. TYPE OF LOCK

Naturally the type of lock and key corresponds with particular location of the door fitting. You can find following designations in our catalogue as well as in our e-shop:



**PZ** - abbreviation for a key and a lock so called "fabka"



**BB** - a hole for a standard dosic key is a part of fitting



**WC** - set used primarily in lavatories and bathrooms – in order to lock the door there is a WC small handle from the inner side, from the outer side there is a rosette with a keyway thus in case of an emergency the door can be unlocked from the outer side using any flat object.

### 3. COMBINATION OF FITTINGS

Not all doors require a handle. What combination of door fittings do you really need?



Handle handle



Handle knob

### 3. ORIENTATION OF FITTINGS

The decision whether to order left or right handle is nearly the only thing which you need to do yourself and do it well. In order to be able to decide there is a simple help – if you use your right hand to open the door, it means it is a right handle. The same applies for the left handle. Left hand will always be used while opening the left handle. If you are able to open left handle using your right hand, it is the wrong way to do so or you stand with your back facing the door. In order to respect the instruction principles we would like to add some more specific graphics which you will surely find helpful.

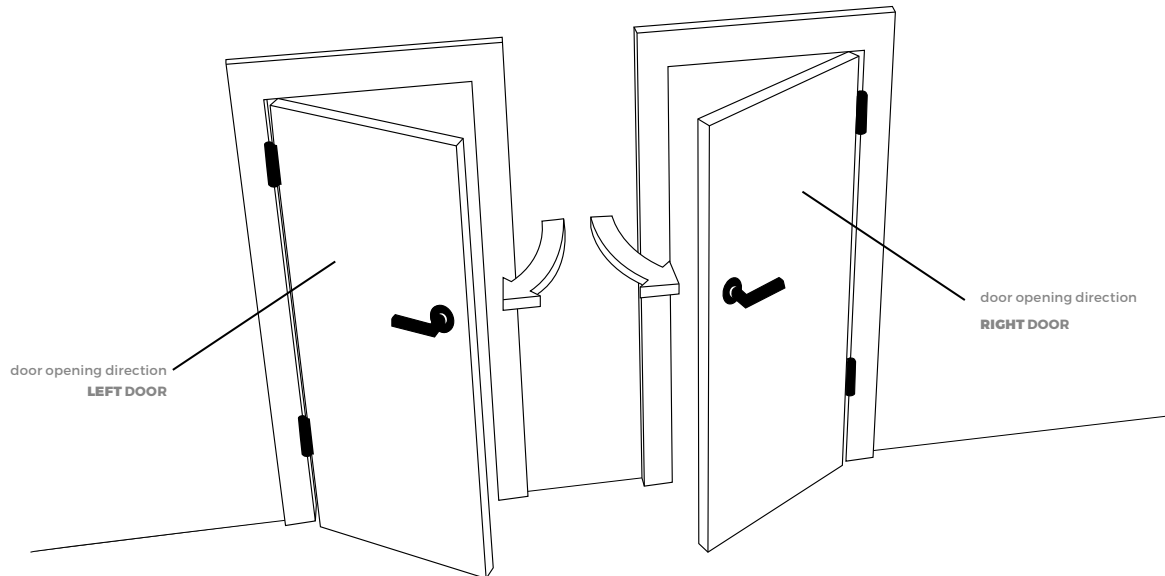

#### What is a PITCH of label fitting?

It is a distance between a handle axis and your door key. This figure is absolutely crucial when buying the right plate fitting. The most common pitches are 72 and 90 mm, up to 92 mm in case of security door.

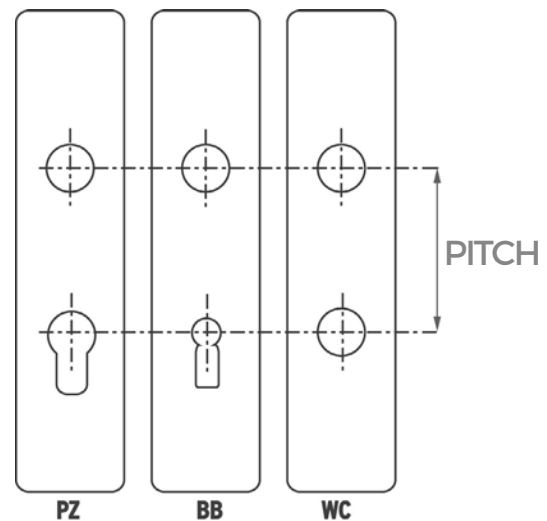



## VÝBĚR CYLINDRICKÉ VLOŽKY

Pro správný výběr cylindrické vložky potřebujete znát její celkovou délku. Položte osu upevňovacího šroubu vložky na střed pravítka a změřte oba rozměry - A i B.

Při měření nezapomeňte připočítat tloušťku štítku nebo rozety na každé straně dveří.

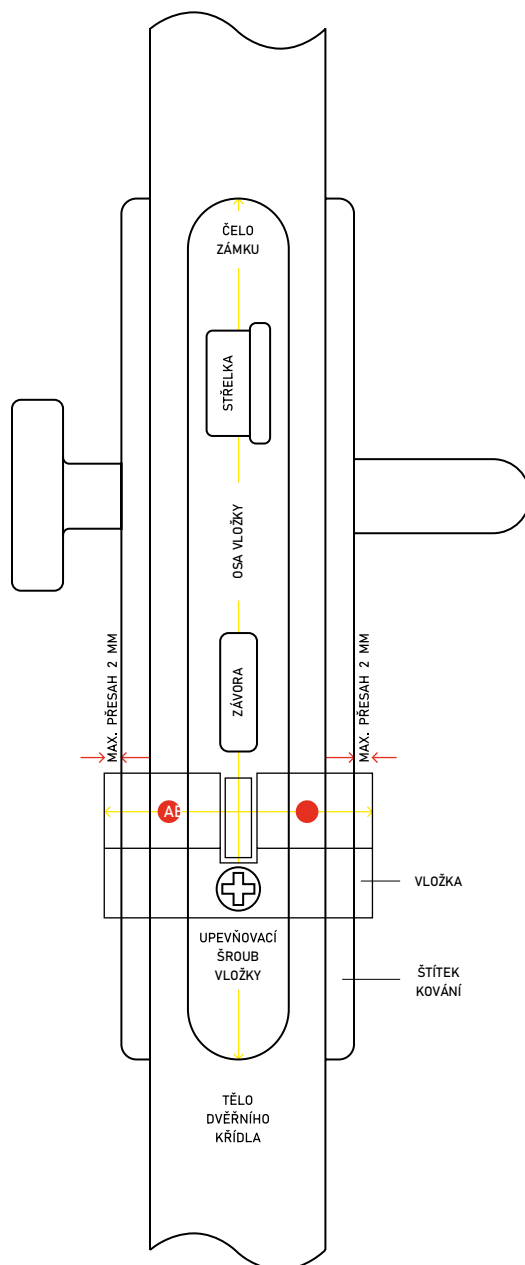

## VLOŽKA S OTOČNÝM KNOFLÍKEM

Pozor - důležitá je nejen informace o délce (tedy rozměrech A a B), ale i upřesnění, zda knoflík bude na kratší nebo delší straně vložky.

## BEZPEČNOSTNÍ VLOŽKA

Pozor - z pohledu bezpečnosti je zcela zásadní, aby cylindrická vložka lícovala s vnějším štítem kování a nepřechňovala o více, než 1mm. Zabrání to jejímu násilnému vylomení.

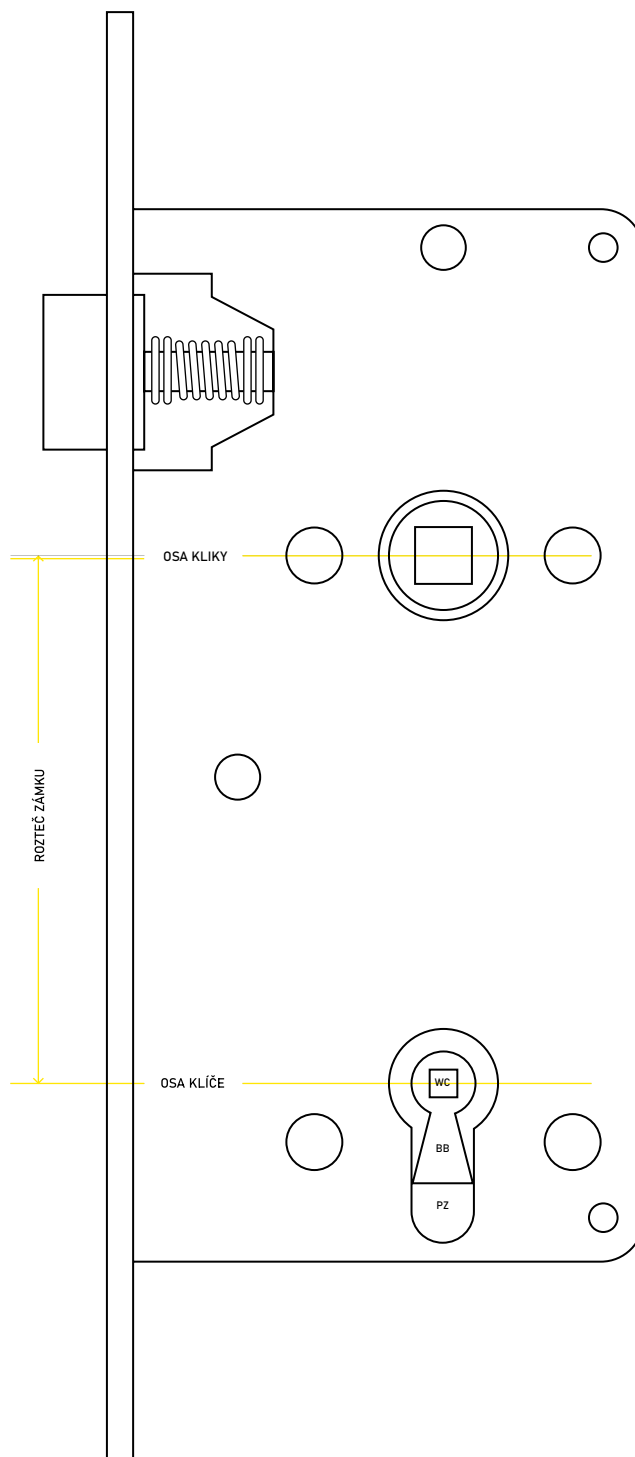

## VÝBĚR ŠTÍTOVÉHO KOVÁNÍ

Při volbě štítového kování je nutné změřit rozteč - jedná se o vzdálenost mezi otvorem pro kliku a otvorem pro klíč. Nejběžnější rozteče jsou 72mm a 90mm, u bezpečnostního kování 92mm.

## JAK U NÁS NAKOUPÍTE?

Vybrali jste si to správné a nejkrásnější dveřní kování a nevíte, kde koupit nebo jak objednat? Pro výběr a nákup našich dveřních kování je vám k dispozici.

### Síť našich obchodních partnerů

spolupracujeme s řadou skvělých partnerů (distributorů a prodejců dveří, dveřních kování a bytových doplňků, architektů či bytových designérských studií) - seznam naleznete na [www.matekliku.cz/prodejni-mista](http://www.matekliku.cz/prodejni-mista)



### 02 Firemní prodejna Cobra

Jeremiášova 2633, Praha 13

### 03 E-shop

[www.matekliku.cz](http://www.matekliku.cz)

### 04 E-mail

objednejte přímo na emailu [objednavky@cobra-cz.cz](mailto:objednavky@cobra-cz.cz)

Naším hlavním cílem je vaše spokojenost. Proto pokud v katalogu nebo na [www.matekliku.cz](http://www.matekliku.cz) naleznete informaci, které zcela nerozumíte, kontaktujte nás nebo naše obchodní partnery, rádi vám poradíme. Telefonní číslo: +420 235 003 107 nebo mobilní číslo: +420 602 440 628.

Veškeré změny technického charakteru i základních cen jsou vyhrazeny. Uvedené základní ceny bez DPH platí do vydání nového katalogu nebo jeho aktualizace. Právo na tiskové chyby vyhrazeno. Skutečná barva nebo vzhled výrobku a rozměr se může lišit.

**Dveřní kování je certifikováno dle ČSN 19006** a je určeno k montáži na standardní interiérové dveře. Montáž doporučujeme svěřit odborné firmě.

Informací není nikdy dost. Webové stránky [www.matekliku.cz](http://www.matekliku.cz) vám nabídnou více informací o našich produktech, službách i řadu dalších potřebných informací.

online katalog a eshop s kompletní nabídkou COBRA



informace o novinkách a trendech v sekci Designový svět

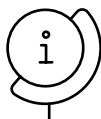

asistenta prodeje - sekci, ve které můžete snadno podle vašich parametrů filtrovat kování, ze kterých budete vybírat



montážní návody a certifikace



...a řadu dalších informací

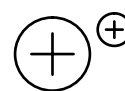

# COBRA®

**To, co je pro ženu krásný malý šperk nebo pro muže správný kapesníček v saku, může být pro váš byt nebo dům správně zvolená klika.**

Můžete investovat mnoho času i peněz do volby podlah, oken nebo třeba kuchyňské linky a bude to úplně v pořádku. Šperkem, který zvýrazní styl vaší domácnosti, se ale mohou stát právě kliky a kování na vašich dveřích. Nejde totiž jen o funkční prostředek k otevírání dveří - při správné volbě skutečně plní funkci estetického doplňku, kterého se každodenně dotýkáme, vnímáme ho, a který by měl respektovat osobitost a design našeho bytu či domu.

**What a beautiful little piece of jewellery does for a woman or appropriately chosen handkerchief in a jacket for a man, well selected door handle can do for your flat or house.**

You can surely invest plenty of time and money in the right choice of floorboards, windows or even a kitchen line and it will be perfectly fine. However, the gem that may enhance your household style can simply be the right choice of door handles and fittings. It is not just functional device for opening doors, but also - if appropriately selected - it can undoubtedly perform the function of an aesthetic accessory which we touch and perceive on daily basis. It should therefore respect the distinctiveness and the design of our flat or house.



# PREMIUM

COBRA   
design by NOVAGE

- 21 Infinity
- 21 Spectra
- 21 Ultima

Kanelaz

- 22 Kanelaz 1745



# Spectra

COBRA



	CZK		EUR	
	bez DPH	s DPH	bez DPH	s DPH
Bez sp. rozet	3855,0	4665,0	151,1	181,5
rozeta BB, PZ (pár)	515,0	623,0	20,2	24,4
WC set	805,0	974,0	31,5	37,1

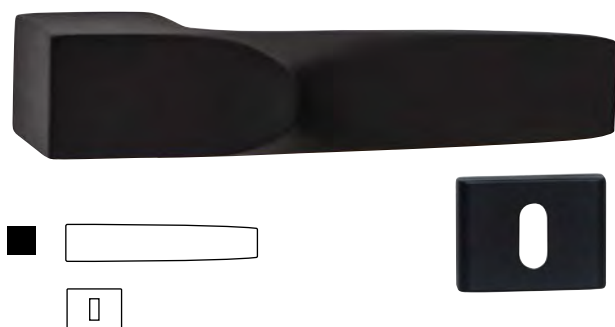

# Spectra

COBRA



	CZK		EUR	
	bez DPH	s DPH	bez DPH	s DPH
Bez sp. rozet	3625,0	4386,3	142,0	170,4
rozeta BB, PZ (pár)	460,0	560,0	18,0	21,8
WC set	750,0	910,0	29,3	35,5

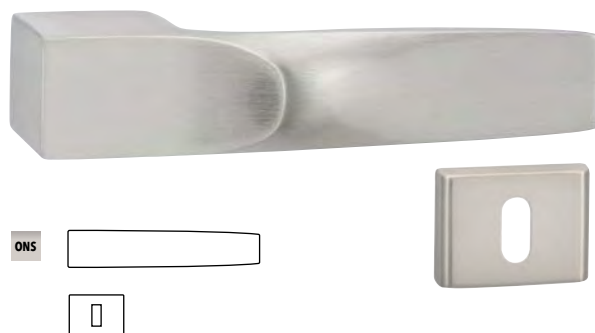

# Infinity

COBRA



	CZK		EUR	
	bez DPH	s DPH	bez DPH	s DPH
Bez sp. rozet	3855,0	4664,6	151,1	181,5
rozeta BB, PZ (pár)	515,0	623,0	20,2	24,4
WC set	805,0	974,0	31,5	37,1



# Infinity

COBRA



	CZK		EUR	
	bez DPH	s DPH	bez DPH	s DPH
Bez sp. rozet	3625,0	4386,3	142,0	170,4
rozeta BB, PZ (pár)	460,0	560,0	18,0	21,8
WC set	750,0	910,0	29,3	35,5

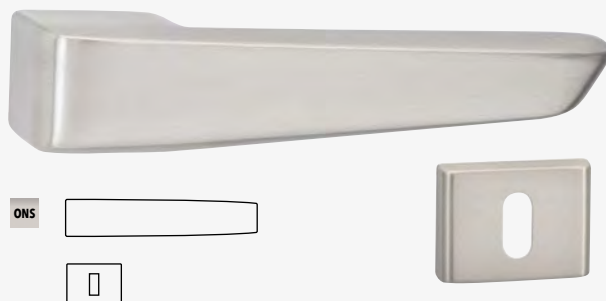

# Ultima

COBRA



	CZK		EUR	
	bez DPH	s DPH	bez DPH	s DPH
Bez sp. rozet	3855,0	4664,6	151,1	181,5
rozeta BB, PZ (pár)	515,0	623,0	20,2	24,4
WC set	805,0	974,0	31,5	37,1



# Ultima

COBRA



	CZK		EUR	
	bez DPH	s DPH	bez DPH	s DPH
Bez sp. rozet	3625,0	4386,3	142,0	170,4
rozeta BB, PZ (pár)	460,0	560,0	18,0	21,8
WC set	750,0	910,0	29,3	35,5

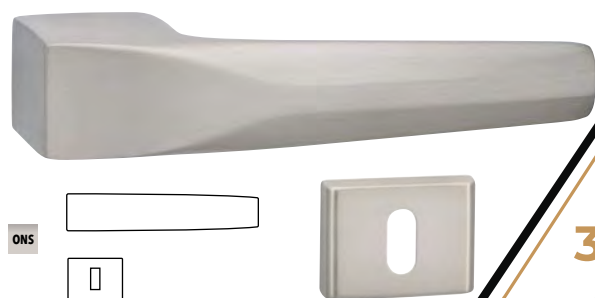

## Kanelaz kliky 1745

	CZK		EUR	
	bez DPH	s DPH	bez DPH	s DPH
Klika bez s.r.	2280,0	2758,8	89,4	107,3
Klika BB/PZ	2550,0	3085,5	100,0	120,0
Klika WC	2790,0	3375,9	109,4	131,3



ONS

	CZK		EUR	
	bez DPH	s DPH	bez DPH	s DPH
Klika bez s.r.	2280,0	2758,8	89,4	107,3
Klika BB/PZ	2550,0	3085,5	100,0	120,0
Klika WC	2790,0	3375,9	109,4	131,3



OS

	CZK		EUR	
	bez DPH	s DPH	bez DPH	s DPH
Klika bez s.r.	2280,0	2758,8	89,4	107,3
Klika BB/PZ	2550,0	3085,5	100,0	120,0
Klika WC	2790,0	3375,9	109,4	131,3



MB

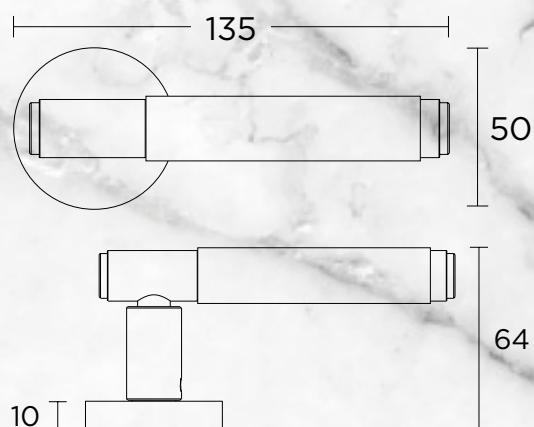

## Kanelaz dveřní koule 1745

	CZK		EUR	
	bez DPH	s DPH	bez DPH	s DPH
Koule S05 kus	2220,0	2686,2	87,1	104,5
Koule S05 pár	4445,0	5378,5	176,1	210,9

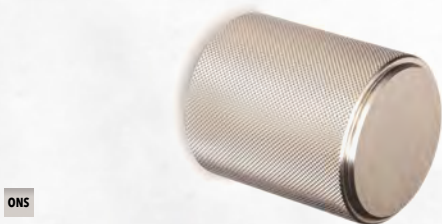

ONS

	CZK		EUR	
	bez DPH	s DPH	bez DPH	s DPH
Koule S05 kus	2220,0	2686,2	87,1	104,5
Koule S05 pár	4445,0	5378,5	176,1	210,9

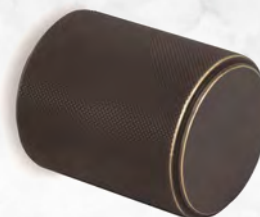

OS

	CZK		EUR	
	bez DPH	s DPH	bez DPH	s DPH
Koule S05 kus	2220,0	2686,2	87,1	104,5
Koule S05 pár	4445,0	5378,5	176,1	210,9

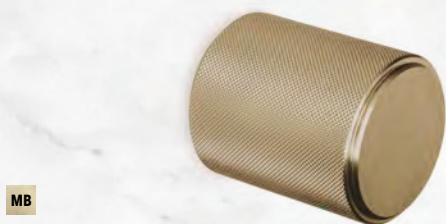

MB

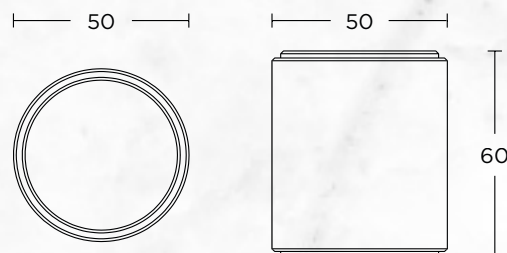

# Kanelaz dveřní madla 1745



ONS

	CZK		EUR	
	bez DPH	s DPH	bez DPH	s DPH
Madlo S05 210 kus	2485,0	3006,9	97,5	117,0
Madlo S05 210 pár	4975,0	6019,8	195,1	234,1
Madlo S05 400 kus	3060,0	3702,6	120,0	144,0
Madlo S05 400 pár	6120,0	7405,2	240,0	288,0

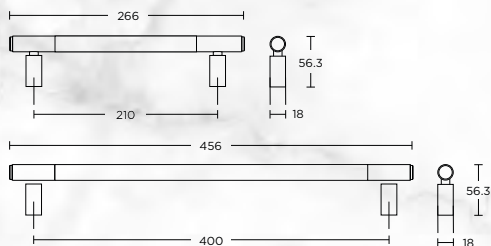

MB

	CZK		EUR	
	bez DPH	s DPH	bez DPH	s DPH
Madlo S05 210 kus	2485,0	3006,9	97,5	117,0
Madlo S05 210 pár	4975,0	6019,8	195,1	234,1
Madlo S05 400 kus	3060,0	3702,6	120,0	144,0
Madlo S05 400 pár	6120,0	7405,2	240,0	288,0

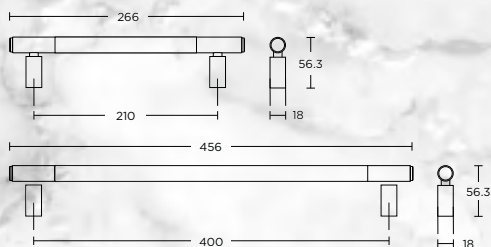

OS

	CZK		EUR	
	bez DPH	s DPH	bez DPH	s DPH
Madlo S05 210 kus	2485,0	3006,9	97,5	117,0
Madlo S05 210 pár	4975,0	6019,8	195,1	234,1
Madlo S05 400 kus	3060,0	3702,6	120,0	144,0
Madlo S05 400 pár	6120,0	7405,2	240,0	288,0

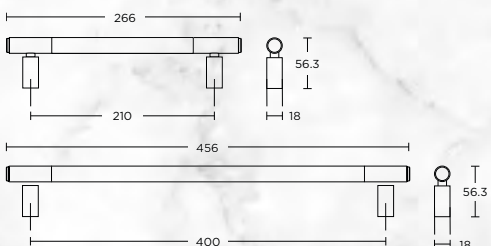



# IN

## Nerez Classic

MATT STAINLESS STEEL CLASSIC

26 Bianca-R  
26 Giussy-R  
26 Giussy-S  
26 Nova-S  
26 Sali-R  
26 Sali-S  
27 Gaia-S  
27 Ufo-R

27 Vision-R  
27 Vision-R plochá rozeta  
27 Vision-S  
27 Vision-S plochá rozeta  
28 Koule pevná Star  
28 Koule pevná Stella





## Bianca-R

**IN** 200 tis. **KR**

<b>CZK</b>	bez DPH	s DPH
🔑 BB/PZ	1020,0	1234,2
WC	1275,0	1542,8
🔑 PZ-LI/RE	1275,0	1542,8
<b>EUR</b>	bez DPH	s DPH
🔑 BB/PZ	39,9	47,9
WC	49,9	59,9
🔑 PZ-LI/RE	49,9	59,9

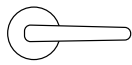

— 128 —



— 55 —  
— 68 —



**IN**

## Giussy-R

**IN** 200 tis. **KR**

<b>CZK</b>	bez DPH	s DPH
🔑 BB/PZ	760,0	919,6
WC	1020,0	1234,2
🔑 PZ-LI/RE	1020,0	1234,2
<b>EUR</b>	bez DPH	s DPH
🔑 BB/PZ	29,8	35,8
WC	39,9	47,8
🔑 PZ-LI/RE	39,9	47,8



— 127 —



— 55 —  
— 69 —



**IN** **OCN** **OFS**

## Giussy-S

**IN** 200 tis. **KR**

<b>CZK</b>	bez DPH	s DPH
🔑 BB/PZ	965,0	1167,7
WC	1210,0	1464,1
🔑 PZ-LI/RE	1210,0	1464,1
<b>EUR</b>	bez DPH	s DPH
🔑 BB/PZ	37,8	45,3
WC	47,4	56,9
🔑 PZ-LI/RE	47,4	56,9

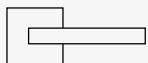

— 127 —



— 55 —  
— 70 —



**IN**

## Nova-S

**IN** 200 tis. **KR**

<b>CZK</b>	bez DPH	s DPH
🔑 BB/PZ	890,0	1076,9
WC	1160,0	1403,6
🔑 PZ-LI/RE	1160,0	1403,6
<b>EUR</b>	bez DPH	s DPH
🔑 BB/PZ	34,8	41,8
WC	45,3	54,4
🔑 PZ-LI/RE	45,3	54,4

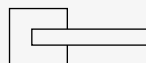

— 134 —



— 55 —  
— 62 —



**IN**

## Sali-R

**IN** 200 tis. **KR**

<b>CZK</b>	bez DPH	s DPH
🔑 BB/PZ	635,0	768,4
WC	890,0	1076,9
🔑 PZ-LI/RE	890,0	1076,9
<b>EUR</b>	bez DPH	s DPH
🔑 BB/PZ	24,8	29,7
WC	34,8	41,8
🔑 PZ-LI/RE	34,8	41,8



— 135 —



— 55 —  
— 79 —



**IN**

## Sali-S

**IN** 200 tis. **KR**

<b>CZK</b>	bez DPH	s DPH
🔑 BB/PZ	715,0	865,2
WC	955,0	1155,6
🔑 PZ-LI/RE	955,0	1155,6
<b>EUR</b>	bez DPH	s DPH
🔑 BB/PZ	27,9	33,5
WC	37,3	44,8
🔑 PZ-LI/RE	37,3	44,8



— 135 —



— 55 —  
— 79 —



**IN**

## Gaia-S

200 tis.

	CZK	bez DPH	s DPH
🔑 BB/PZ		805,0	974,1
🔑 WC		870,0	1052,7
<b>EUR</b>			
		bez DPH	s DPH
🔑 BB/PZ		31,4	37,6
🔑 WC		34,1	40,9

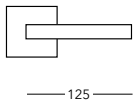

Černá IN

## Ufo-R

200 tis. KR

	CZK	bez DPH	s DPH
🔑 BB/PZ		665,0	804,7
🔑 WC		900,0	1089,0
🔑 PZ-LI/RE		900,0	1089,0
<b>EUR</b>			
		bez DPH	s DPH
🔑 BB/PZ		26,0	31,2
🔑 WC		35,2	42,3
🔑 PZ-LI/RE		35,2	42,3

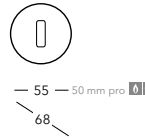
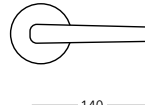

IN

## Vision-R

200 tis. KR

	CZK	bez DPH	s DPH
🔑 BB/PZ		600,0	726,0
🔑 WC		850,0	1028,5
🔑 PZ-LI/RE		850,0	1028,5
<b>EUR</b>			
		bez DPH	s DPH
🔑 BB/PZ		23,5	28,2
🔑 WC		33,1	39,8
🔑 PZ-LI/RE		33,1	39,8

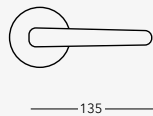

IN

## Vision-R plochá rozeta

200 tis. KR

	CZK	bez DPH	s DPH
🔑 BB/PZ		1140,0	1379,4
🔑 WC		1710,0	2069,1
<b>EUR</b>			
		bez DPH	s DPH
🔑 BB/PZ		44,7	53,6
🔑 WC		67,1	80,5

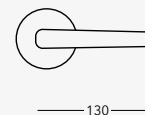

IN

plochá magnetická rozeta, hloubka rozety 3mm

## Vision-S

200 tis. KR

	CZK	bez DPH	s DPH
🔑 BB/PZ		850,0	1028,5
🔑 WC		1085,0	1312,9
🔑 PZ-LI/RE		1085,0	1312,9
<b>EUR</b>			
		bez DPH	s DPH
🔑 BB/PZ		33,1	39,8
🔑 WC		42,4	50,9
🔑 PZ-LI/RE		42,4	50,9

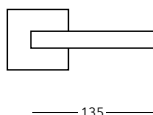

IN

## Vision-S plochá rozeta

200 tis. KR

	CZK	bez DPH	s DPH
🔑 BB/PZ		1140,0	1379,4
🔑 WC		1710,0	2069,1
<b>EUR</b>			
		bez DPH	s DPH
🔑 BB/PZ		44,7	53,6
🔑 WC		67,1	80,5

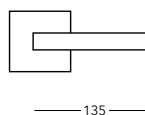

IN

plochá magnetická rozeta, hloubka rozety 3mm

## Koule pevná Star

KR

<b>CZK</b>	bez DPH	s DPH
cena ks	405,0	490,1
<b>EUR</b>	bez DPH	s DPH
cena ks	17,7	20,8

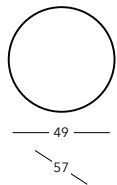

IN

Samostatná koule bez rozety na vyžádání.  
Varianty provedení levá, pravá, pevná, otočná.

## Koule pevná Stella

KR

<b>CZK</b>	bez DPH	s DPH
cena ks	445,0	538,5
<b>EUR</b>	bez DPH	s DPH
cena ks	19,3	22,7

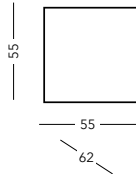

IN

Samostatná koule bez rozety na vyžádání.  
Varianty provedení levá, pravá, pevná, otočná.





# IN

## Nerez Object

### MATT STAINLESS STEEL OBJECT

32	Diva-R III	33	Loft-R ovál III	35	Plaza-S III	36	Vision-R ovál III
32	Element-R III	34	Paola	35	Sali	37	Vision-R III
32	Giusy	34	Paola-R III	35	Sali-R III	37	Vision-S III
32	Giusy-R III	34	Pavla-R III	35	Sali-S III	37	Zoe-R III
32	Giusy-S III	34	Pavla-S III	36	Ufo	37	Koule pevná Luna
33	Iris-R III	34	Pavla-H	36	Ufo Slim	37	Koule pevná Star
33	Iris-S III	34	Plaza	36	Ufo-R III	37	Koule pevná Stella
33	Loft	35	Plaza-H	36	Ufo-R ovál III		
33	Loft-R III	35	Plaza-R III	36	Vision		

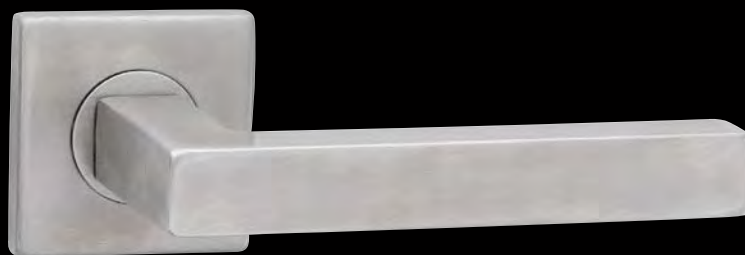

**Nerezové kování představuje skvělou volbu vhodnou i pro nejnáročnější uživatele. Díky modernímu vzhledu je často používán i v designových interiérech či moderních objektech. Vysoká odolnost a bezúdržbovost předurčuje nerezové kliky i do více zatěžovaných prostor.**

Stainless steel fittings represent a great choice which even the most demanding end – users will find satisfactory. Thanks to its modern look it is often used in design interiors or modern premises. High resilience and barely any maintenance predetermines stainless steel handles to be fitted even in more stressed areas.





## Diva-R III

200 tis. KR

<b>CZK</b>	bez DPH	s DPH
BB/PZ	480,0	580,8
WC	605,0	732,1
<b>EUR</b>	bez DPH	s DPH
BB/PZ	18,7	22,4
WC	23,7	28,4

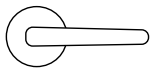

— 130 —



— 55 —  
65



IN

## Element-R III

200 tis. KR

<b>CZK</b>	bez DPH	s DPH
BB/PZ	480,0	580,8
WC	550,0	665,5
PZ-LI/RE	795,0	962,0
<b>EUR</b>	bez DPH	s DPH
BB/PZ	18,7	22,4
WC	21,4	25,7
PZ-LI/RE	31,2	37,4

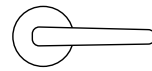

— 135 —



— 52 —  
60



IN

## Giussy

200 tis. KR

<b>CZK</b>	bez DPH	s DPH
BB/PZ	550,0	665,5
WC	760,0	919,6
PZ-LI/RE	835,0	1010,4
<b>EUR</b>	bez DPH	s DPH
BB/PZ	21,4	25,7
WC	29,8	35,8
PZ-LI/RE	32,7	39,3

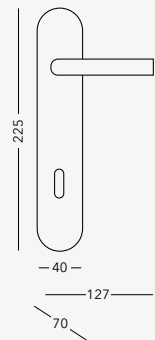

— 225 —  
— 40 —  
— 127 —  
70



IN



## Giussy-R III

200 tis. KR

<b>CZK</b>	bez DPH	s DPH
BB/PZ	495,0	599,0
WC	685,0	828,9
PZ-LI/RE	685,0	828,9
<b>EUR</b>	bez DPH	s DPH
BB/PZ	19,3	23,2
WC	26,9	32,2
PZ-LI/RE	26,9	32,2

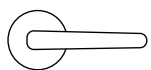

— 127 —



— 55 —  
67



IN F4 F9 F1

## Giussy-S III

200 tis. KR

<b>CZK</b>	bez DPH	s DPH
BB/PZ	625,0	756,3
W47C	750,0	907,5
PZ-LI/RE	815,0	986,2
<b>EUR</b>	bez DPH	s DPH
BB/PZ	24,3	29,2
WC	29,4	35,2
PZ-LI/RE	31,9	38,3

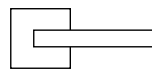

— 127 —



— 55 —  
67



IN F1 F9

## Iris-R III

200 tis. KR

	CZK	bez DPH	s DPH
BB/PZ	490,0	490,0	592,9
WC	615,0	615,0	744,2
EUR		bez DPH	s DPH
BB/PZ		19,1	22,9
WC		24,1	28,9

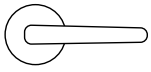

— 130 —

— 55 —  
55

IN

## Iris-S III

200 tis. KR

	CZK	bez DPH	s DPH
BB/PZ	595,0	595,0	720,0
WC	810,0	810,0	980,1
EUR		bez DPH	s DPH
BB/PZ		23,3	27,9
WC		31,6	37,9

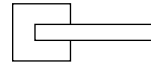

— 130 —

— 55 —  
55

IN

## Loft

200 tis.

	CZK	bez DPH	s DPH
BB/PZ	550,0	550,0	665,5
WC	760,0	760,0	919,6
PZ-LI/RE	835,0	835,0	1010,4
EUR		bez DPH	s DPH
BB/PZ		21,4	25,7
WC		29,8	35,8
PZ-LI/RE		32,7	39,3

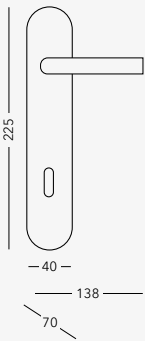

225

— 40 —

— 138 —

70



IN

## Loft-R III

KR

	CZK	bez DPH	s DPH
BB/PZ	345,0	345,0	417,5
WC	450,0	450,0	544,5
PZ-LI/RE	515,0	515,0	623,2
EUR		bez DPH	s DPH
BB/PZ		13,4	16,1
WC		17,6	21,1
PZ-LI/RE		20,1	24,2

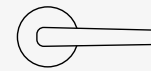

— 138 —

— 55 —  
65

IN

Loft-R  
ová III

200 tis. BV KR

	CZK	bez DPH	s DPH
BB/PZ	520,0	520,0	629,2
WC	665,0	665,0	804,7
PZ-LI/RE	840,0	840,0	1016,4
EUR		bez DPH	s DPH
BB/PZ		20,3	24,4
WC		26,0	31,2
PZ-LI/RE		33,0	39,6

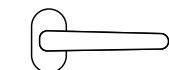

— 138 —



— 65 —

— 32 —

57



IN

Nelze namontovat s klasickým zadlabávacím zámkem

## Paola

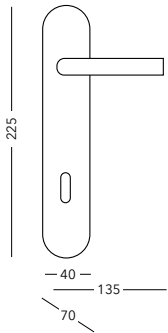

IN



<b>CZK</b>		bez DPH	s DPH
🔑	BB/PZ	550,0	665,5
	WC	760,0	919,6
🔑	PZ-LI/RE	835,0	1010,4
<b>EUR</b>		bez DPH	s DPH
🔑	BB/PZ	21,4	25,7
	WC	29,8	35,8
🔑	PZ-LI/RE	32,7	39,3

## Paola-R III

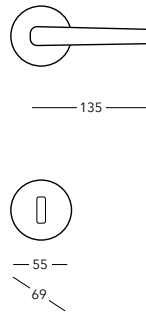

IN



<b>CZK</b>		bez DPH	s DPH
🔑	BB/PZ	345,0	417,5
	WC	465,0	562,7
🔑	PZ-LI/RE	525,0	635,3
<b>EUR</b>		bez DPH	s DPH
🔑	BB/PZ	13,4	16,1
	WC	18,0	21,7
🔑	PZ-LI/RE	20,6	24,7

## Pavla-R III

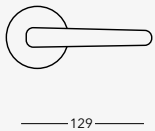

IN



<b>CZK</b>		bez DPH	s DPH
🔑	BBB/PZ	600,0	726,0
	WC	850,0	1028,5
🔑	PZ-LI/RE	850,0	1028,5
<b>EUR</b>		bez DPH	s DPH
🔑	B/PZ	23,5	28,2
	WC	33,1	39,8
🔑	PZ-LI/RE	33,1	39,8

## Pavla-S III

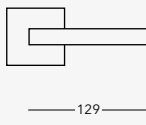

IN



<b>CZK</b>		bez DPH	s DPH
🔑	BB/PZ	600,0	726,0
	WC	850,0	1028,5
🔑	PZ-LI/RE	850,0	1028,5
<b>EUR</b>		bez DPH	s DPH
🔑	BB/PZ	23,5	28,2
	WC	33,1	39,8
🔑	PZ-LI/RE	33,1	39,8

## Pavla-H

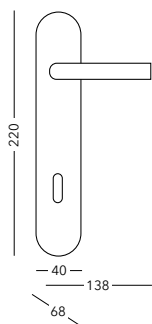

IN



<b>CZK</b>		bez DPH	s DPH
🔑	BB/PZ	590,0	713,9
	WC	805,0	974,1
<b>EUR</b>		bez DPH	s DPH
🔑	BB/PZ	23,1	27,7
	WC	31,5	37,8

## Plaza

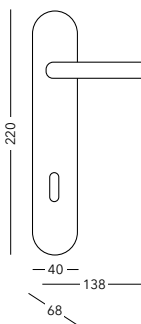

IN



<b>CZK</b>		bez DPH	s DPH
🔑	BB/PZ	535,0	647,4
	WC	750,0	907,5
🔑	PZ-LI/RE	815,0	986,2
<b>EUR</b>		bez DPH	s DPH
🔑	BB/PZ	21,0	25,2
	WC	29,4	35,2
🔑	PZ-LI/RE	31,9	38,3

## Plaza-H

200 tis. KR

	CZK	bez DPH	s DPH
BB/PZ	590,0	590,0	713,9
WC	805,0	805,0	974,1
	EUR	bez DPH	s DPH
BB/PZ	23,1	23,1	27,7
WC	31,5	31,5	37,8

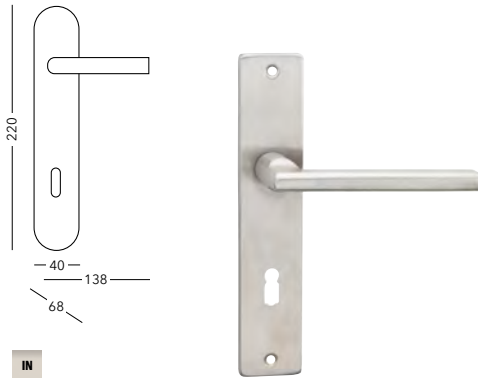

IN

## Plaza-R III

200 tis. KR

	CZK	bez DPH	s DPH
BB/PZ	525,0	525,0	635,3
WC	635,0	635,0	768,4
PZ-LI/RE	635,0	635,0	768,4
	EUR	bez DPH	s DPH
BB/PZ	20,5	20,5	24,6
WC	24,7	24,7	29,6
PZ-LI/RE	24,7	24,7	29,6



IN

## Plaza-S III

200 tis. KR

	CZK	bez DPH	s DPH
BB/PZ	635,0	635,0	768,4
WC	740,0	740,0	895,4
PZ-LI/RE	740,0	740,0	895,4
	EUR	bez DPH	s DPH
BB/PZ	24,7	24,7	29,6
WC	28,9	28,9	34,7
PZ-LI/RE	28,9	28,9	34,7



IN

## Sali

200 tis. KR

	CZK	bez DPH	s DPH
BB/PZ	535,0	535,0	647,4
WC	750,0	750,0	907,5
PZ-LI/RE	825,0	825,0	998,3
	EUR	bez DPH	s DPH
BB/PZ	21,0	21,0	25,2
WC	29,4	29,4	35,2
PZ-LI/RE	32,3	32,3	38,8

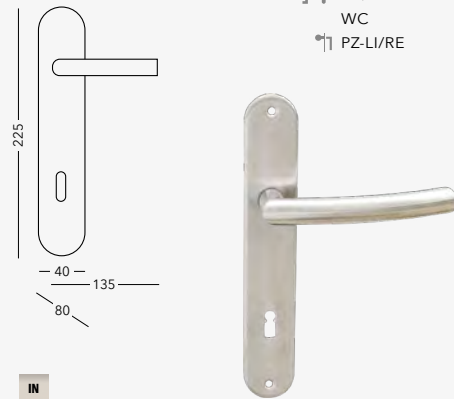

IN

## Sali-R III

200 tis. KR

	CZK	bez DPH	s DPH
BB/PZ	345,0	345,0	417,5
WC	465,0	465,0	562,7
PZ-LI/RE	525,0	525,0	635,3
	EUR	bez DPH	s DPH
BB/PZ	13,4	13,4	16,1
WC	18,0	18,0	21,7
PZ-LI/RE	20,6	20,6	24,7

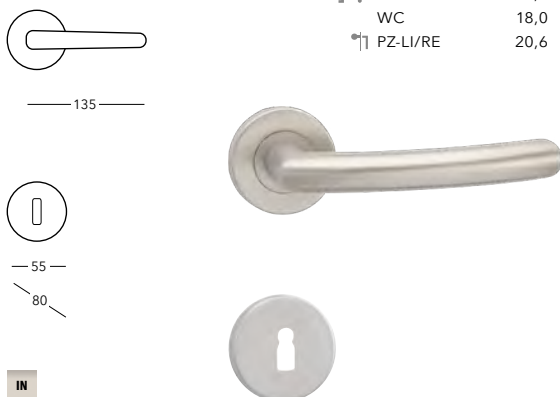

IN

## Sali-S III

200 tis. KR

	CZK	bez DPH	s DPH
BB/PZ	520,0	520,0	629,2
WC	700,0	700,0	847,0
PZ-LI/RE	700,0	700,0	847,0
	EUR	bez DPH	s DPH
BB/PZ	20,3	20,3	24,4
WC	27,3	27,3	32,7
PZ-LI/RE	27,3	27,3	32,7

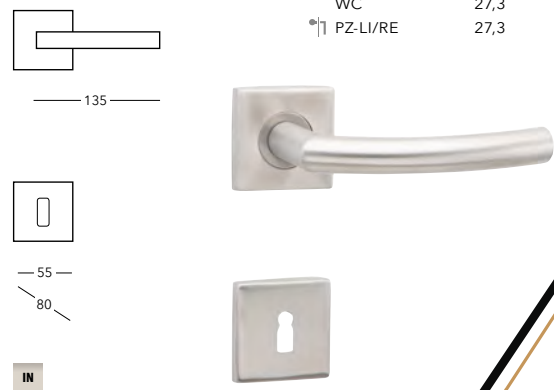

IN

## Ufo

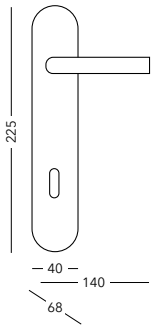

IN



<b>CZK</b>		bez DPH	s DPH
☝	BB/PZ	525,0	635,3
	WC	730,0	883,3
☞	PZ-LI/RE	795,0	962,0
<b>EUR</b>		bez DPH	s DPH
☝	BB/PZ	20,6	24,7
	WC	28,5	34,2
☞	PZ-LI/RE	31,1	37,3

## Ufo Slim

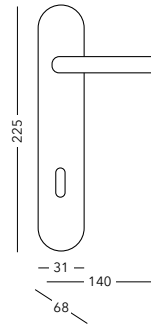

IN



<b>CZK</b>		bez DPH	s DPH
☝	BB/PZ	600,0	726,0
	WC	815,0	986,2
☞	PZ-LI/RE	845,0	1022,4
<b>EUR</b>		bez DPH	s DPH
☝	BB/PZ	23,5	28,2
	WC	31,9	38,3
☞	PZ-LI/RE	33,1	38,9

## Ufo-R III

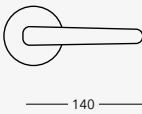

IN



<b>CZK</b>		bez DPH	s DPH
☝	BB/PZ	345,0	417,5
	WC	450,0	544,5
☞	PZ-LI/RE	515,0	623,2
<b>EUR</b>		bez DPH	s DPH
☝	BB/PZ	13,4	16,1
	WC	17,6	21,1
☞	PZ-LI/RE	20,1	24,2

## Ufo-R ovál III

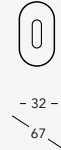
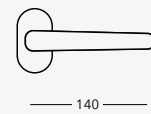

IN



Nelze namontovat s klasickým zadlabávacím zámečkem

<b>CZK</b>		bez DPH	s DPH
☝	BB/PZ	550,0	665,5
	WC	665,0	804,7
☞	PZ-LI/RE	850,0	1028,5
<b>EUR</b>		bez DPH	s DPH
☝	BB/PZ	21,4	25,7
	WC	26,0	31,2
☞	PZ-LI/RE	33,1	39,8

## Vision

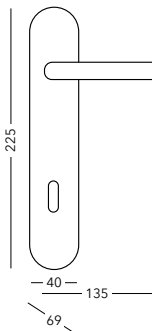

IN



<b>CZK</b>		bez DPH	s DPH
☝	BB/PZ	535,0	647,4
	WC	750,0	907,5
☞	PZ-LI/RE	825,0	998,3
<b>EUR</b>		bez DPH	s DPH
☝	BB/PZ	21,0	25,2
	WC	29,4	35,2
☞	PZ-LI/RE	32,3	38,8

## Vision-R ovál III

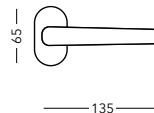

IN



<b>CZK</b>		bez DPH	s DPH
☝	BB/PZ	550,0	665,5
	WC	665,0	804,7
☞	PZ-LI/RE	850,0	1028,5
<b>EUR</b>		bez DPH	s DPH
☝	BB/PZ	21,4	25,7
	WC	26,0	31,2
☞	PZ-LI/RE	33,1	39,8

## Vision-R III

200 tis. KR

CZK		bez DPH	s DPH
BB/PZ	300,0	300,0	363,0
WC	485,0	485,0	586,9
PZ-LI/RE	550,0	550,0	665,5

EUR		bez DPH	s DPH
BB/PZ	11,7	11,7	14,1
WC	18,9	18,9	22,7
PZ-LI/RE	21,4	21,4	25,7

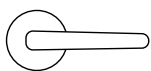

—135—



—55—

63



IN

## Vision-S III

200 tis. KR

CZK		bez DPH	s DPH
BB/PZ	365,0	365,0	441,7
WC	580,0	580,0	701,8
PZ-LI/RE	700,0	700,0	847,0

EUR		bez DPH	s DPH
BB/PZ	14,3	14,3	17,1
WC	22,7	22,7	27,2
PZ-LI/RE	27,3	27,3	32,7

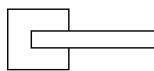

—135—



—55—

70



IN

## Zoe-R III

KR

CZK		bez DPH	s DPH
BB/PZ	730,0	730,0	883,3
WC	1000,0	1000,0	1210,0
PZ-LI/RE	1000,0	1000,0	1210,0

EUR		bez DPH	s DPH
BB/PZ	28,5	28,5	34,2
WC	39,0	39,0	46,8
PZ-LI/RE	39,0	39,0	46,8



—146—



—50—

65



IN

ONS

OFS

## Koule pevná Luna

KR

CZK		bez DPH	s DPH
cena ks	680,0	680,0	822,8

EUR		bez DPH	s DPH
cena ks	26,6	26,6	32,3

obj. číslo C4199E6K55

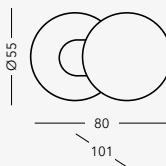

IN

Samostatná koule bez rozety na vyžádání.  
Varianty provedení levá, pravá, pevná, otočná.

## Koule pevná Star

KR

CZK		bez DPH	s DPH
cena ks	405,0	405,0	490,1

EUR		bez DPH	s DPH
cena ks	17,7	17,7	20,8

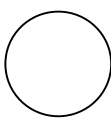

—49—

57



IN

Samostatná koule bez rozety na vyžádání.  
Varianty provedení levá, pravá, pevná, otočná.

## Koule pevná Stella

KR

CZK		bez DPH	s DPH
cena ks	445,0	445,0	538,5

EUR		bez DPH	s DPH
cena ks	19,3	19,3	22,7



—55—

62



IN

Samostatná koule bez rozety na vyžádání.  
Varianty provedení levá, pravá, pevná, otočná.

IN

# Nerez Project

STAINLESS STEEL PROJECT

41	Loft	43	Ufo	45	Vision
41	Loft-krátký štít	43	Ufo-krátký štít	45	Vision-krátký štít
41	Loft-R	43	Ufo-R	45	Vision-R
41	Loft-ovál	43	Ufo-ovál	45	Vision-ovál







# Vision

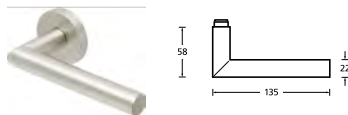

# Ufo

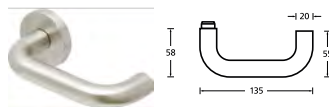

# Loft

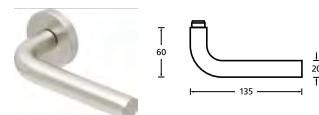

**Kovová vratná pružina**  
Metal spring

**Objektové kování**  
Hardware for object

**1 mil.** Testováno na životnost 1 milion cyklů  
Tested for 1 milion cycles

**Fixační kovové výstupky**  
Fixing metal pins

**Rychlá montáž**  
Quick assembly

**Kuličkové ložisko**  
Ball-bearing

- Vhodné pro kategorii použití 4
- Kuličkové ložisko v obou rozetích
- Testováno na životnost 1 milion cyklů
- Kování se zvýšenou axiální pevností
- Extrémně vysoká odolnost proti korozi

- Záruka 30 let na mechanismus
- Uchycení základny metrickými šrouby
- Větší průměr kliky 22 mm
- Velmi rychlá montáž

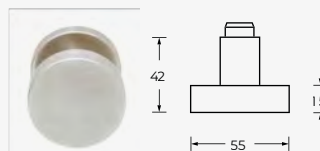
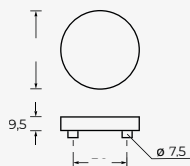

# PullBloc® 4.1



Bezúdržbová kuličková ložiska z tvrzené oceli zajišťují **nízké tření, tichý chod a velmi dlouhou životnost.**

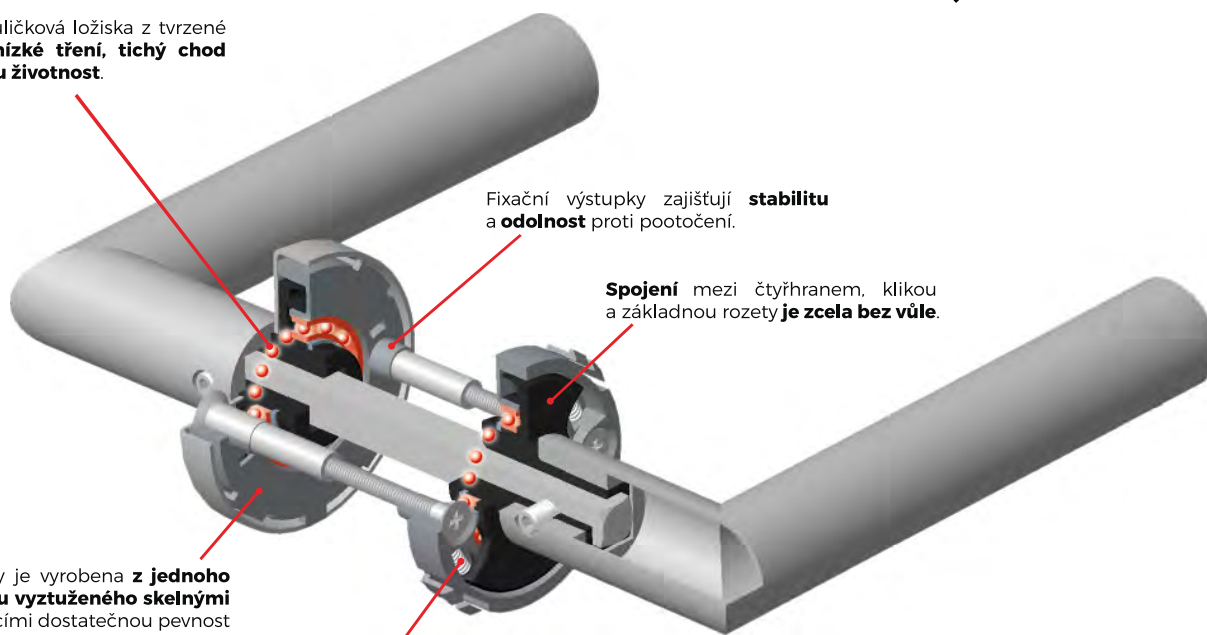

Fixační výstupky zajišťují **stabilitu a odolnost** proti pootočení.

**Spojení** mezi čtyřhranem, klikou a základnou rozetou **je zcela bez vůle.**

Základna rozety je vyrobena **z jednoho kusu polyamidu vztuženého skelnými vlákny** zaručujícími dostatečnou pevnost pouzdra.

**Vratné pružiny** udržují kliky vždy ve správné poloze.

Kategorie použití	Životnost	Hmotnost dveří	Požární odolnost	Ochrana	Odolnost proti korozi	Bezpečnost	Typ ovládání
<b>4*</b>	<b>7</b>	<b>-</b>	<b>0</b>	<b>1</b>	<b>5</b>	<b>0</b>	<b>B</b>

\* ČSN EN 1906, kategorie použití, třída 4: vysoká frekvence používání na dveřích, které jsou předmětem častého hrubého používání, např. fotbalové stadiony, kasárna, veřejné toalety, atd.

# Loft



### PullBloc 3.0

	bez DPH	s DPH		bez DPH	s DPH
<b>CZK</b>					
BB/PZ	2460,0	2976,6			
WC	2850,0	3448,5			
LI/RE	2980,0	3605,8			
<b>EUR</b>					
BB/PZ	96,5	115,8			
WC	111,8	134,1			
LI/RE	116,9	140,2			

IN

# Loft-krátký štít

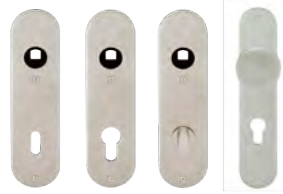

### PullBloc 3.0

	bez DPH	s DPH		bez DPH	s DPH
<b>CZK</b>					
BB/PZ	2460,0	2976,6			
WC	2850,0	3448,5			
LI/RE	2980,0	3605,8			
<b>EUR</b>					
BB/PZ	96,5	115,8			
WC	111,8	134,1			
LI/RE	116,9	140,2			

IN u krátkého štítu pouze rozteč 72mm

# Loft-R



IN

### PullBloc 4.1

	bez DPH	s DPH		bez DPH	s DPH
<b>CZK</b>			<b>EUR</b>		
BB/PZ	1960,0	2371,6	BB/PZ	76,9	92,2
WC	2320,0	2807,2	WC	91,0	109,2
LI/RE	2740,0	3315,4	LI/RE	107,5	128,9

### PullBloc 3.0

	bez DPH	s DPH		bez DPH	s DPH
<b>CZK</b>			<b>EUR</b>		
BB/PZ	1250,0	1512,5	BB/PZ	49,0	58,8
WC	1620,0	1960,2	WC	63,5	76,2
LI/RE	2180,0	2637,8	LI/RE	85,5	102,6

### SlideBloc

	bez DPH	s DPH		bez DPH	s DPH
<b>CZK</b>			<b>EUR</b>		
BB/PZ	980,0	1185,8	BB/PZ	38,4	46,1
WC	1280,0	1548,8	WC	50,2	60,2
LI/RE	1580,0	1911,8	LI/RE	62,0	74,4

# Loft-ovál



IN

### PullBloc 3.0

	bez DPH	s DPH		bez DPH	s DPH
<b>CZK</b>			<b>EUR</b>		
BB/PZ	2120,0	2562,2	BB/PZ	83,1	99,8
WC	2390,0	2891,9	WC	93,7	112,5
LI/RE	2560,0	3097,6	LI/RE	100,4	120,5



# Vision

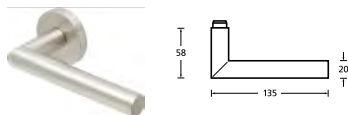

# Ufo

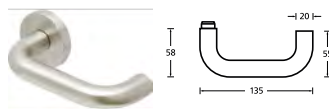

# Loft

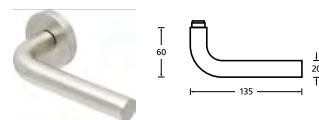

**Kovová vratná pružina**  
Metal spring

**Objektové kování**  
Hardware for object

**Rychlá montáž**  
Quick assembly

**Kuličkové ložisko**  
Ball-bearing

- Vhodné pro kategorii použití 3
- Kuličkové ložisko v obou rozetách
- Vysoká odolnost proti korozi

- Záruka 30 let na mechanismus
- Uchycení základny samořeznými šrouby
- Snadná montáž

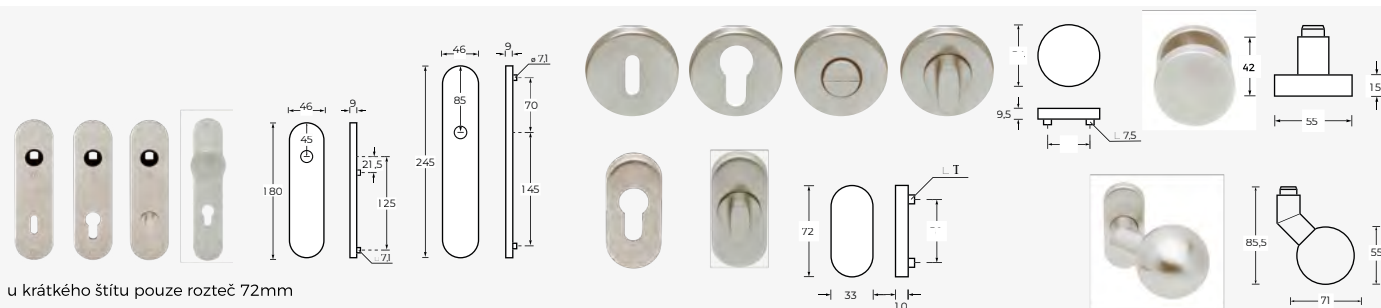

u krátkého štítu pouze rozteč 72mm

# PullBloc® 3.0



Bezúdržbová kuličková ložiska z tvrzené oceli zajišťují **nízké tření, tichý chod a velmi dlouhou životnost.**

Fixační výstupky zajišťují **stabilitu a odolnost** proti pootočení.

**Spojení** mezi čtyřhranem, klikou a základnou rozety **je zcela bez vůle.**

Základna rozety je vyrobena z **jednoho kusu polyamidu vyztuženého skelnými vlákny** zaručujícími dostatečnou pevnost pouzdra.

**Vratné pružiny** udržují kliky vždy ve správné poloze.

Kategorie použití	Životnost	Hmotnost dveří	Požární odolnost	Ochrana	Odolnost proti korozi	Bezpečnost	Typ ovládání
<b>3*</b>	<b>7</b>	<b>-</b>	<b>0</b>	<b>0</b>	<b>3</b>	<b>0</b>	<b>B</b>

\* ČSN EN 1906, kategorie použití, třída 3: vysoká frekvence používání veřejností nebo jinými uživateli s malou motivací o pečlivé používání a tam, kde je vysoká pravděpodobnost nesprávného použití, např. dveře u veřejných kanceláří.

# Ufo



### PullBloc 3.0

	bez DPH	s DPH		bez DPH	s DPH
<b>CZK</b>					
BB/PZ	2460,0	2976,6			
WC	2850,0	3448,5			
LI/RE	2980,0	3605,8			
<b>EUR</b>					
BB/PZ	96,5	115,8			
WC	111,8	134,1			
LI/RE	116,9	140,2			

IN

# Ufo-krátký štít

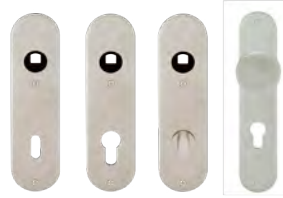

### PullBloc 3.0

	bez DPH	s DPH		bez DPH	s DPH
<b>CZK</b>					
BB/PZ	2460,0	2976,6			
WC	2850,0	3448,5			
LI/RE	2980,0	3605,8			
<b>EUR</b>					
BB/PZ	96,5	115,8			
WC	111,8	134,1			
LI/RE	116,9	140,2			

IN u krátkého štítu pouze rozteč 72mm

# Ufo-R



IN

### PullBloc 4.1

	bez DPH	s DPH		bez DPH	s DPH
<b>CZK</b>			<b>EUR</b>		
BB/PZ	1960,0	2371,6	BB/PZ	76,9	92,2
WC	2320,0	2807,2	WC	91,0	109,2
LI/RE	2740,0	3315,4	LI/RE	107,5	128,9

### PullBloc 3.0

	bez DPH	s DPH		bez DPH	s DPH
<b>CZK</b>			<b>EUR</b>		
BB/PZ	1250,0	1512,5	BB/PZ	49,0	58,8
WC	1620,0	1960,2	WC	63,5	76,2
LI/RE	2180,0	2637,8	LI/RE	85,5	102,6

### SlideBloc

	bez DPH	s DPH		bez DPH	s DPH
<b>CZK</b>			<b>EUR</b>		
BB/PZ	980,0	1185,8	BB/PZ	38,4	46,1
WC	1280,0	1548,8	WC	50,2	60,2
LI/RE	1580,0	1911,8	LI/RE	62,0	74,4

# Ufo-ová



IN

### PullBloc 3.0

	bez DPH	s DPH		bez DPH	s DPH
<b>CZK</b>			<b>EUR</b>		
BB/PZ	2120,0	2565,2	BB/PZ	83,1	99,8
WC	2390,0	2891,9	WC	93,7	112,5
LI/RE	2560,0	3097,6	LI/RE	100,4	120,5



# Vision

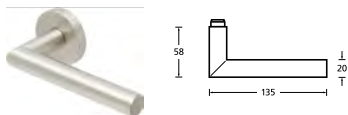

## Kovová vratná pružina

Metal spring

- Vhodné pro kategorii použití 3
- Testováno na životnost 200 000 cyklů
- Kluzné ložisko v obou rozetách
- Záruka 10 let na mechanismus

# Ufo

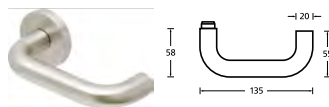

## Objektové kování

Hardware for object

- Vysoká odolnost proti korozi
- Uchycení základny samořeznými šrouby
- Snadná montáž

# Loft

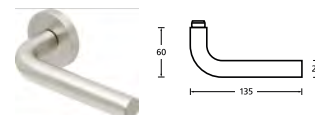

## Rychlá montáž

Quick assembly

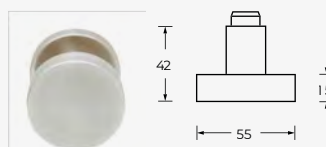
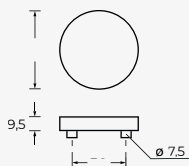

# SlideBloc®



Bezúdržbová kluzná ložiska zajišťují **tichý chod a vysokou spolehlivost.**

Fixační výstupky zajišťují **stabilitu a odolnost** proti pootočení.

**Spojení** mezi čtyřhranem, klikou a základnou rozety **je zcela bez vůle.**

Základna rozety je vyrobena z **jednoho kusu polyamidu vyztuženého skelnými vlákny** zaručujícími dostatečnou pevnost pouzdra.

**Vratné pružiny** udržují kliky vždy ve správné poloze.

Kategorie použití	Životnost	Hmotnost dveří	Požární odolnost	Ochrana	Odolnost proti korozi	Bezpečnost	Typ ovládání
<b>3*</b>	<b>7</b>	<b>-</b>	<b>0</b>	<b>0</b>	<b>3</b>	<b>0</b>	<b>B</b>

\* ČSN EN 1906, kategorie použití, třída 3: vysoká frekvence používání veřejností nebo jinými uživateli s malou motivací o pečlivé používání a tam, kde je vysoká pravděpodobnost nesprávného použití, např. dveře u veřejných kancelářích.

# Vision



### PullBloc 3.0

CZK	bez DPH	s DPH
BB/PZ	2460,0	2976,6
WC	2850,0	3448,5
LI/RE	2980,0	3605,8

EUR	bez DPH	s DPH
BBB/PZ	96,5	115,8
WC	111,8	134,1
LI/RE	116,9	140,2

IN

# Vision-krátký štít



### PullBloc 3.0

CZK	bez DPH	s DPH
BB/PZ	2460,0	2976,6
WC	2850,0	3448,5
LI/RE	2980,0	3605,8

EUR	bez DPH	s DPH
BB/PZ	96,5	115,8
WC	111,8	134,1
LI/RE	116,9	140,2

IN u krátkého štítu pouze rozteč 72mm

# Vision-R



IN

### PullBloc 4.1

CZK	bez DPH	s DPH	EUR	bez DPH	s DPH
BBB/PZ	1960,0	2371,6	BB/PZ	76,9	92,2
WC	2320,0	2807,2	WC	91,0	109,2
LI/RE	2740,0	3315,4	LI/RE	107,5	128,9

### PullBloc 3.0

CZK	bez DPH	s DPH	EUR	bez DPH	s DPH
BB/PZ	1250,0	1512,5	BB/PZ	49,0	58,8
WC	1620,0	1960,2	WC	63,5	76,2
LI/RE	2180,0	2637,8	LI/RE	85,5	102,6

### SlideBloc

CZK	bez DPH	s DPH	EUR	bez DPH	s DPH
BB/PZ	980,0	1185,8	BB/PZ	38,4	46,1
WC	1280,0	1548,8	WC	50,2	60,2
LI/RE	1580,0	1911,8	LI/RE	62,0	74,4

# Vision-ovál



IN

### PullBloc 3.0

CZK	bez DPH	s DPH
BB/PZ	2120,0	2562,2
WC	2390,0	2891,9
LI/RE	2560,0	3097,6

EUR	bez DPH	s DPH
BB/PZ	83,1	99,8
WC	93,7	112,5
LI/RE	100,4	120,5



# OCS

## Chrom matný

### SATIN CHROME

48 Alexis-R	49 Milena	51 1485
48 Alt-wien	50 Milena-R	51 1495
48 Elegant	50 Orion	51 1515
48 Elsa-S	50 Orion-R	52 1555
48 Esme-S	50 Q-arte	52 1505
48 Spring-S	50 Q-arte-S	
49 Jerome-R	51 865	52 Koule pevná Victory
49 Laura	51 1085	
49 Laura-R	51 1115	
49 Mega-S	51 1145	



Hledáte praktické řešení pro vaše dveře? Chromová klika v matné úpravě je to pravé. Nenápadně ozdobí váš interiér, lehké záblesky studených odstínů se výborně hodí do moderních i tradičních interiérů.

Are you searching for a practical solution for your door? Chrome handle in frosted design is what you are looking for. Without calling too much attention it will decorate your interior. Light flashes of cold shades beautifully match both modern as well as traditional interiors.





## Alexis-R

200 tis. KR

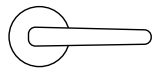

OCS ONS

	CZK	bez DPH	s DPH
BB/PZ	500,0	500,0	605,0
WC	630,0	630,0	762,3
PZ-LI/RE	700,0	700,0	847,0

	EUR	bez DPH	s DPH
BB/PZ	19,5	19,5	23,4
WC	24,5	24,5	29,4
PZ-LI/RE	27,4	27,4	32,9



## Alt-Wien

200 tis.

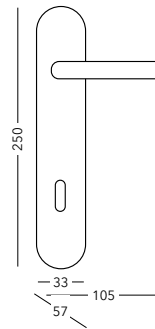

OCS OC ONS OLV OV  
OFS K

	CZK	bez DPH	s DPH
BB/PZ	810,0	810,0	980,1
WC	1030,0	1030,0	1246,3
PZ-LI/RE	1115,0	1115,0	1349,2

	EUR	bez DPH	s DPH
BB/PZ	31,7	31,7	38,0
WC	40,4	40,4	48,4
PZ-LI/RE	43,6	43,6	52,4



## Elegant

200 tis.

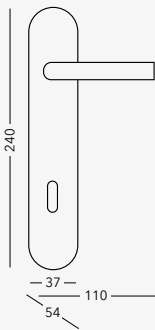

OCS ONS OLV OFS OC  
OV K

	CZK	bez DPH	s DPH
BB/PZ	685,0	685,0	828,9
WC	840,0	840,0	1016,4
PZ-LI/RE	925,0	925,0	1119,3

	EUR	bez DPH	s DPH
BB/PZ	26,8	26,8	32,1
WC	32,9	32,9	39,5
PZ-LI/RE	36,2	36,2	43,5



## Elsa-S

200 tis. PR

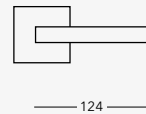

OCS ONS

	CZK	bez DPH	s DPH
BB/PZ	850,0	850,0	1028,5
WC	1100,0	1100,0	1331,0

	EUR	bez DPH	s DPH
BB/PZ	33,3	33,3	40,0
WC	43,0	43,0	51,6

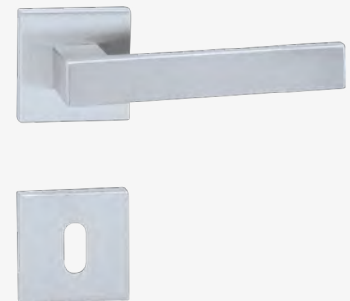

## Esme-S

200 tis. PR

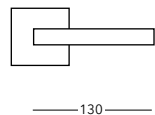

OCS ONS

	CZK	bez DPH	s DPH
BB/PZ	850,0	850,0	1028,5
WC	1100,0	1100,0	1331,0

	EUR	bez DPH	s DPH
BB/PZ	33,3	33,3	40,0
WC	43,0	43,0	51,6

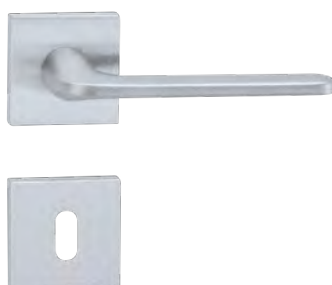

## Spring-S

PR

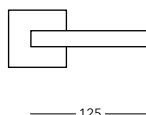

OCS ONS

	CZK	bez DPH	s DPH
BB/PZ	1260,0	1260,0	1524,6
WC	1365,0	1365,0	1651,7

	EUR	bez DPH	s DPH
BB/PZ	49,4	49,4	59,3
WC	53,5	53,5	64,2



## Jerome-R

200 tis. KR

	CZK	bez DPH	s DPH
BB/PZ	630,0	630,0	762,3
WC	750,0	750,0	907,5
PZ-LI/RE	860,0	860,0	1040,6
	EUR	bez DPH	s DPH
BB/PZ	24,7	24,7	29,6
WC	29,4	29,4	35,3
PZ-LI/RE	33,7	33,7	40,4

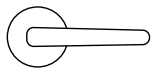

125



52

60



OCS

## Laura

200 tis.

	CZK	bez DPH	s DPH
BB/PZ	490,0	490,0	592,9
WC	605,0	605,0	732,1
PZ-LI/RE	670,0	670,0	810,7
	EUR	bez DPH	s DPH
BB/PZ	19,1	19,1	22,9
WC	23,7	23,7	28,4
PZ-LI/RE	26,2	26,2	31,4

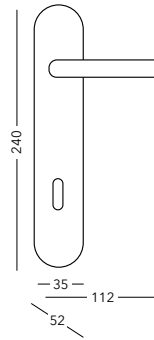

240

35 112

52



OCS ONS OLV OFS OC

ECO

## Laura-R

200 tis. KR

	CZK	bez DPH	s DPH
BB/PZ	575,0	575,0	695,8
WC	700,0	700,0	847,0
PZ-LI/RE	755,0	755,0	913,6
	EUR	bez DPH	s DPH
BB/PZ	22,4	22,4	26,9
WC	27,4	27,4	32,9
PZ-LI/RE	29,5	29,5	35,4

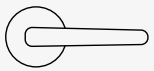

112



52

54



OCS ONS OLV OFS OC

ECO

## Mega-S

200 tis. KR

	CZK	bez DPH	s DPH
BB/PZ	795,0	795,0	962,0
WC	935,0	935,0	1131,4
PZ-LI/RE	990,-	990,-	1197,9
	EUR	bez DPH	s DPH
BB/PZ	31,2	31,2	37,4
WC	36,6	36,6	43,9
PZ-LI/RE	38,8	38,8	46,9

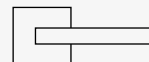

125



55

63



OCS

## Milena

200 tis.

	CZK	bez DPH	s DPH
BB/PZ	410,-	410,-	496,-
WC	540,-	540,-	653,-
PZ-LI/RE	590,-	590,-	714,-
	EUR	bez DPH	s DPH
BB/PZ	16,1	16,1	19,3
WC	21,2	21,2	25,4
PZ-LI/RE	23,1	23,1	27,8

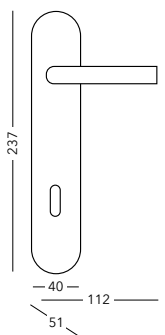

237

40 112

51



OCS ONS OFS

## Milena-R

200 tis. KR

	CZK	bez DPH	s DPH
BB/PZ	460,-	460,-	557,-
WC	590,-	590,-	714,-
PZ-LI/RE	650,-	650,-	787,-
	EUR	bez DPH	s DPH
BB/PZ	18,0	18,0	21,6
WC	23,1	23,1	27,8
PZ-LI/RE	25,5	25,5	30,6

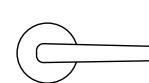

112



52

51



OCS ONS

# Orion

W 200 tis.

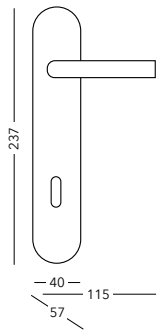

OCS ONS

CZK	bez DPH	s DPH
BB/PZ	435,0	526,4
WC	650,0	786,5
PZ-LI/RE	715,0	865,2

EUR	bez DPH	s DPH
BB/PZ	17,0	20,5
WC	25,4	30,4
PZ-LI/RE	27,9	33,4



# Orion-R

W 200 tis. KR

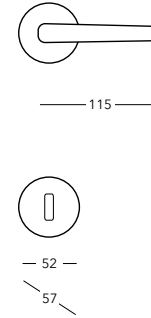

OCS ONS

CZK	bez DPH	s DPH
BB/PZ	595,0	720,0
WC	735,0	889,4
PZ-LI/RE	785,0	949,9

EUR	bez DPH	s DPH
BB/PZ	23,3	27,9
WC	28,7	34,4
PZ-LI/RE	30,8	36,9



# Q-arte

W

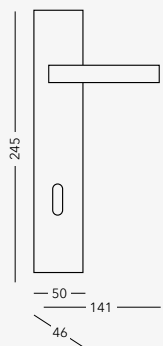

OCS ONS

CZK	bez DPH	s DPH
BB/PZ	1600,0	1936,0
WC	1920,0	2323,2
PZ-LI/RE	2080,0	2516,8

EUR	bez DPH	s DPH
BB/PZ	62,7	75,3
WC	75,3	90,4
PZ-LI/RE	81,6	97,9



# Q-arte-S

W KR

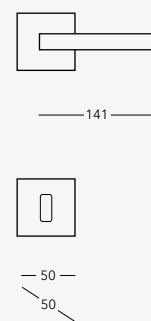

OCS ONS

CZK	bez DPH	s DPH
BB/PZ	1390,0	1681,9
WC	1820,0	2202,2

EUR	bez DPH	s DPH
BB/PZ	54,5	65,4
WC	71,4	85,6



# 865

W 1 mil. KR

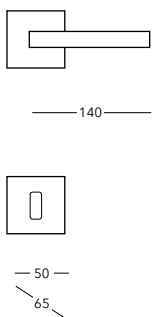

OCS ONS Černá

CZK	bez DPH	s DPH
BB/PZ	1290,0	1560,9
WC	1610,0	1948,1

EUR	bez DPH	s DPH
BB/PZ	50,6	60,7
WC	63,1	75,8



# 1145

W 1 mil. KR

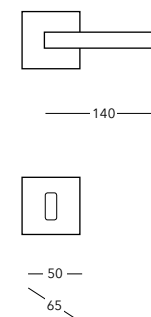

OCS ONS

CZK	bez DPH	s DPH
BB/PZ	1500,0	1815,0
WC	1720,0	2081,2

EUR	bez DPH	s DPH
BB/PZ	58,8	70,6
WC	67,5	80,9



# 1085

W 1 mil. KR

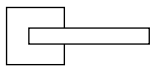

— 140 —



— 50 —  
65

OCS ONS

CZK	bez DPH	s DPH
BB/PZ	1590,0	1923,9
WC	1810,0	2190,1

EUR	bez DPH	s DPH
BB/PZ	62,9	75,5
WC	71,6	86,6



# 1115

W 1 mil. KR

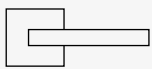

— 140 —



— 50 —  
60

OCS ONS

CZK	bez DPH	s DPH
BB/PZ	1490,0	1802,9
WC	1810,0	2190,1

EUR	bez DPH	s DPH
BB/PZ	57,5	69
WC	69,8	83,8



# 1485

W 1 mil. KR

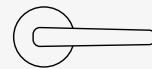

— 131 —



— 50 —  
68

OCS OC

CZK	bez DPH	s DPH
BB/PZ	960,0	1161,6
WC	1390,0	1681,9

EUR	bez DPH	s DPH
BB/PZ	37,6	45,2
WC	54,5	65,4



# 1495

W 1 mil. KR

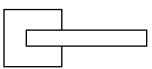

— 130,7 —



— 50 —  
64

OCS ONS OC

CZK	bez DPH	s DPH
BB/PZ	960,0	1161,6
WC	1290,0	1560,9

EUR	bez DPH	s DPH
BB/PZ	37,6	45,2
WC	50,6	60,7



# 1515

W 1 mil. KR

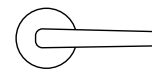

— 143 —



— 50 —  
53

OCS OC

CZK	bez DPH	s DPH
BB/PZ	960,0	1161,6
WC	1390,0	1681,9

EUR	bez DPH	s DPH
BB/PZ	37,6	45,2
WC	54,5	65,4



## 1505

1 mil. KR

CZK	bez DPH	s DPH
BB/PZ	960,0	1161,6
WC	1390,0	1681,9

EUR	bez DPH	s DPH
BB/PZ	37,6	45,2
WC	54,5	65,4

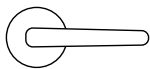

— 130,6 —



— 50 —

64

OCS OC



## 1555

1 mil. KR

CZK	bez DPH	s DPH
BB/PZ	1720,0	2081,2
WC	2040,0	2468,4

EUR	bez DPH	s DPH
BB/PZ	67,5	80,9
WC	80,0	96,0

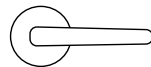

— 145 —



— 50 —

51

OCS ONS Černá



## Koule pevná Victory

KR

CZK	bez DPH	s DPH
cena ks	480,0	580,8

EUR	bez DPH	s DPH
cena ks	18,7	22,4

obj. číslo C415919602

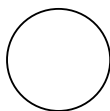

— Ø 55 —

65

OCS ONS OFS OCN



Samostatná koule bez rozety na vyžádání.  
Varianty provedení levá, pravá, pevná, otočná.

## ZÁRUKY

Za naše výrobky a služby ručíme. Na naše výrobky poskytujeme záruky v rozsahu od dvou do deseti let. Na kliky COBRA se můžete spolehnout.

## ZÁRUKA AŽ 10 LET

Na naše designové kování Convex garantujeme minimálně 200 000 otvíracích a zavíracích cyklů a na všechny chromované produkty řady CONVEX poskytujeme 10 letou záruku proti jakýmkoli známám koroze.

[www.matekliku.cz](http://www.matekliku.cz)

## GUARANTEES

Our products and services are guaranteed. We provide guarantees on our products ranging from two to ten years. COBRA handles can be relied on.

## GUARANTEE UP TO 10 YEARS

With our design fitting Convex we guarantee minimum 200.000 opening and closing cycles and we also provide a 10-year guarantee against any signs of corrosion on all chrome products in Convex line.

[www.matekliku.cz](http://www.matekliku.cz)



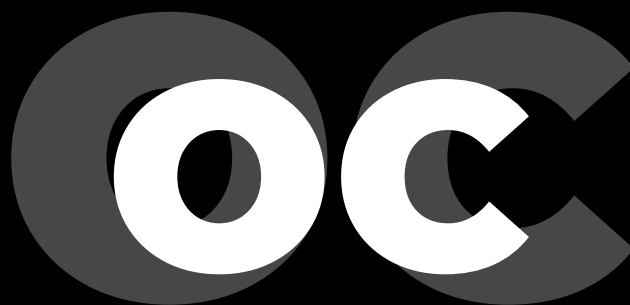

# Chrom lesklý

POLISHED CHROME

56	Alt-wien	56	Orion-R	57	1505
56	Elegant	56	1105	57	1515
56	Laura	57	1485		
56	Laura-R	57	1495		



**Chromové kliky pečlivě leštíme do vysokého lesku. Důraz klademe na vysokou kvalitu zpracování, protože lesklý povrch kliky nesnese sebemenší nedokonalost povrchu. Lesklý a studený „stříbrný“ odstín je vhodnou variantou do moderních světlých prostorů.**

Chrome handles are polished into a glossy appearance. We put emphasis on high quality of processing as we know that shiny surface of the handle does not combine with any little imperfection of the surface. Glossy and cold "silver" shade is a very suitable choice for modern light areas.





## Alt-wien

200 tis.

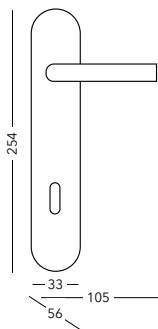

OCS OC ONS OFS OLV  
OV K



	CZK	bez DPH	s DPH
BB/PZ	810,0	810,0	980,1
WC	1030,0	1030,0	1246,3
PZ-LI/RE	1115,0	1115,0	1349,2
	EUR	bez DPH	s DPH
BB/PZ	31,7	31,7	38,0
WC	40,4	40,4	48,4
PZ-LI/RE	43,6	43,6	52,4

## Elegant

200 tis.

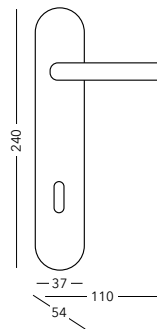

OCS OC ONS OFS OLV  
OV K



	CZK	bez DPH	s DPH
BB/PZ	685,0	685,0	828,9
WC	840,0	840,0	1016,4
PZ-LI/RE	925,0	925,0	1119,3
	EUR	bez DPH	s DPH
BB/PZ	26,8	26,8	32,1
WC	32,9	32,9	39,5
PZ-LI/RE	36,2	36,2	43,5

## Laura

200 tis.

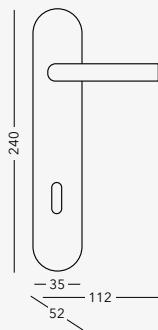

OCS OC ONS OFS OLV



	CZK	bez DPH	s DPH
BB/PZ	490,0	490,0	592,9
WC	605,0	605,0	732,1
PZ-LI/RE	670,0	670,0	810,7
	EUR	bez DPH	s DPH
BB/PZ	19,1	19,1	22,9
WC	23,7	23,7	28,4
PZ-LI/RE	26,2	26,2	31,4

## Laura-R

200 tis. KR

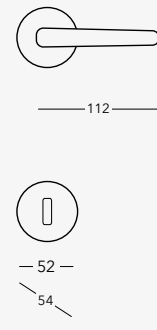

OCS OC ONS OFS OLV



	CZK	bez DPH	s DPH
BB/PZ	575,0	575,0	695,8
WC	700,0	700,0	847,0
PZ-LI/RE	755,0	755,0	913,6
	EUR	bez DPH	s DPH
BB/PZ	22,4	22,4	26,9
WC	27,4	27,4	32,9
PZ-LI/RE	29,5	29,5	35,4

## Orion-R

200 tis. KR



OCS OC ONS OFS OLV



	CZK	bez DPH	s DPH
BB/PZ	595,0	595,0	720,0
WC	735,0	735,0	889,4
PZ-LI/RE	785,0	785,0	949,9
	EUR	bez DPH	s DPH
BB/PZ	23,3	23,3	27,9
WC	28,7	28,7	34,4
PZ-LI/RE	30,8	30,8	36,9

## 1105

1 mil. KR

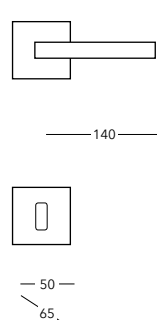

OC



	CZK	bez DPH	s DPH
BB/PZ	1445,0	1445,0	1748,5
WC	1700,0	1700,0	2057,0
	EUR	bez DPH	s DPH
BB/PZ	56,7	56,7	68,0
WC	66,7	66,7	80,0

## 1485

W 1 mil. KR

	CZK	bez DPH	s DPH
☿ ☿ BB/PZ		1070,0	1294,7
WC		1500,0	1815,0
☿ ☿ EUR		bez DPH	s DPH
☿ ☿ BB/PZ		42,0	50,4
WC		58,8	70,6

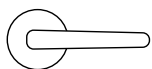

— 131 —

— 50 —  
— 68 —

OCS OC

## 1495

W 1 mil. KR

	CZK	bez DPH	s DPH
☿ ☿ BB/PZ		1030,0	1246,3
WC		1350,0	1633,5
☿ ☿ EUR		bez DPH	s DPH
☿ ☿ BB/PZ		40,4	48,5
WC		52,9	63,5

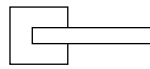

— 130,7 —

— 50 —  
— 64 —

OCS OC ONS

## 1505

W 1 mil. KR

	CZK	bez DPH	s DPH
☿ ☿ BB/PZ		1070,0	1294,7
WC		1500,0	1815,0
☿ ☿ EUR		bez DPH	s DPH
☿ ☿ BB/PZ		42,0	50,4
WC		58,8	70,6



— 130,6 —

— 50 —  
— 64 —

OC ONS

## 1515

W 1 mil. KR

	CZK	bez DPH	s DPH
☿ ☿ BB/PZ		1070,0	1294,7
WC		1440,0	1742,4
☿ ☿ EUR		bez DPH	s DPH
☿ ☿ BB/PZ		42,0	50,4
WC		56,5	67,8



— 143 —

— 50 —  
— 53 —

OCS OC

**BOHATÝ VÝBĚR**

COBRA nabízí svým zákazníkům široký výběr druhů a tvarů kování v pestré škále materiálů a povrchových úprav. Výrobní řady jsou každoročně inovovány také s důrazem na design a styl. Tu správnou kliku si tak u značky COBRA vybere každý.

**MODERNÍ DESIGN**

Sledujeme nejmodernější trendy, ale nezapomínáme ani na tradiční hodnoty. Spolupracujeme se špičkovými designéry a nebojíme se nabídnout ani osobitá řešení. Neustále přinášíme stylové inovace v našich výrobních řadách, abychom zákazníkům nabídli vždy aktuální a moderní design.

[www.cobra-cz.cz](http://www.cobra-cz.cz)

**WIDE RANGE OF PRODUCTS**

COBRA offers a wide range of types and designs of fittings in many different materials and surface treatments. Product lines are innovated annually placing an emphasis on the design and style. Therefore everybody can make his choice with COBRA.

**MODERN DESIGN**

Although we follow the latest trends we also do not forget about traditional values. We cooperate with cutting-edge designers and we are not afraid to offer even more personal solutions. In our collections we keep bringing stylish innovations so that we can offer our customers up-to-date and modern design.

[www.cobra-cz.cz](http://www.cobra-cz.cz)

# ONS

## Níkl matný

SATIN NICKEL

60 Alexis	61 Element-R	63 Orion	65 865
60 Alexis-R	61 Elsa-S	63 Orion-R	65 1085
60 Alt-Wien	62 Esme-S	64 Q-arte	65 1115
60 Aphrodité-S	62 Fap	64 Q-arte-S	65 1145
60 Athena-S	62 Fap-R	64 Spring-S	66 1495
60 Beata-S	62 Laura	64 Vega-S	66 1555
61 Denisa	62 Laura-R	64 Vera-S	
61 Denisa-R	62 Milena	64 Zeus	66 Koule pevná Victory
61 Elegant	63 Milena-R	65 Zeus-R III	
61 Element	63 Omega-S	65 Zoe-R	

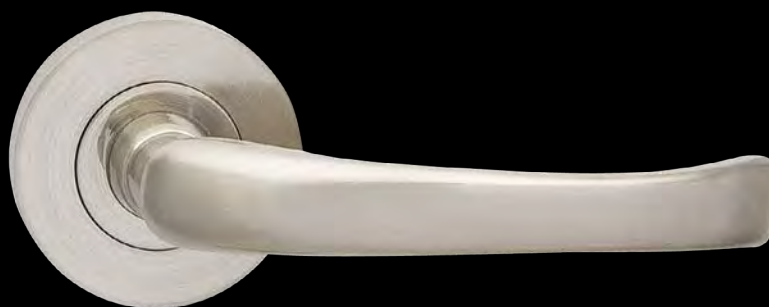

**Níková klika v matné úpravě představuje jednu z nejoblíbenějších variant kování. Ohromí vás lehkými záblesky až do červené barvy a vyniknou téměř v každém moderním interiéru.**

Nickel handle in frosted design represents one of the most popular types of fitting. You will be impressed with light flashes turning red, they will surely stand out in any modern interior.



## Alexis

200 tis.

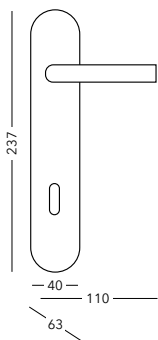

	bez DPH	s DPH
<b>CZK</b>		
BB/PZ	470,0	568,7
WC	595,0	720,0
PZ-LI/RE	660,0	798,6
<b>EUR</b>	bez DPH	s DPH
BB/PZ	18,3	21,9
WC	23,3	27,9
PZ-LI/RE	25,8	30,9



ONS

## Alexis-R

200 tis. KR

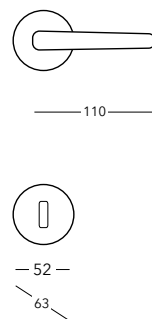

	bez DPH	s DPH
<b>CZK</b>		
BB/PZ	500,0	605,0
WC	630,0	762,3
PZ-LI/RE	700,0	847,0
<b>EUR</b>	bez DPH	s DPH
BB/PZ	19,5	23,4
WC	24,5	29,4
PZ-LI/RE	27,4	32,9



ONS OCS

## Alt-Wien

200 tis.

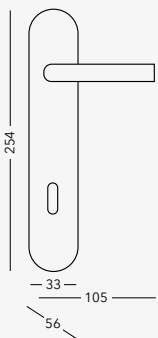

	bez DPH	s DPH
<b>CZK</b>		
BB/PZ	810,0	980,1
WC	1030,0	1246,3
PZ-LI/RE	1115,0	1349,2
<b>EUR</b>	bez DPH	s DPH
BB/PZ	31,7	38,0
WC	40,4	48,4
PZ-LI/RE	43,6	52,4



OCS OC ONS OFS OLV  
OV K

## Aphrodité-S

200 tis. KR

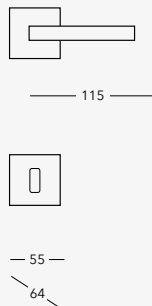

	bez DPH	s DPH
<b>CZK</b>		
BB/PZ	500,0	605,0
WC	630,0	762,3
PZ-LI/RE	700,0	847,0
<b>EUR</b>	bez DPH	s DPH
BB/PZ	19,5	23,4
WC	24,5	29,4
PZ-LI/RE	27,4	33,2



Titan ONS Cerná

## Athena-S

200 tis. KR

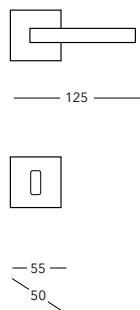

	bez DPH	s DPH
<b>CZK</b>		
BB/PZ	500,0	605,0
WC	630,0	762,0
PZ-LI/RE	700,0	847,0
<b>EUR</b>	bez DPH	s DPH
BB/PZ	19,5	23,4
WC	24,5	29,4
PZ-LI/RE	27,4	33,2

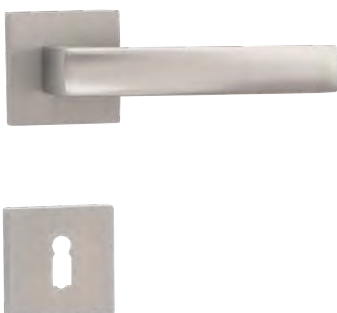

Titan ONS

## Beata-S

200 tis. KR

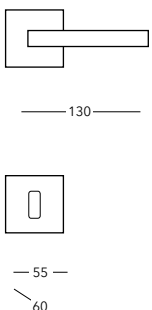

	bez DPH	s DPH
<b>CZK</b>		
BB/PZ	700,0	847,0
WC	820,0	992,2
<b>EUR</b>	bez DPH	s DPH
BB/PZ	27,4	32,9
WC	32,0	38,4



ONS

# Denisa

200 tis.

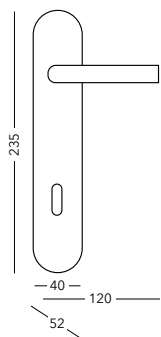

	CZK	bez DPH	s DPH
BB/PZ	375,0	375,0	453,8
WC	500,0	500,0	605,0
PZ-LI/RE	565,0	565,0	683,7
	EUR	bez DPH	s DPH
BB/PZ	14,5	14,5	17,5
WC	19,5	19,5	23,4
PZ-LI/RE	22,0	22,0	26,4

ONS

# Denisa-R

200 tis.

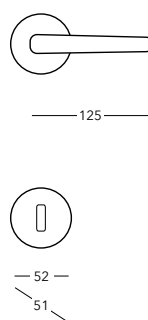

	CZK	bez DPH	s DPH
BB/PZ	415,0	415,0	502,2
WC	530,0	530,0	641,3
PZ-LI/RE	595,0	595,0	720,0
	EUR	bez DPH	s DPH
BB/PZ	16,2	16,2	19,5
WC	20,8	20,8	24,9
PZ-LI/RE	23,3	23,3	27,9

ONS

# Elegant

200 tis.

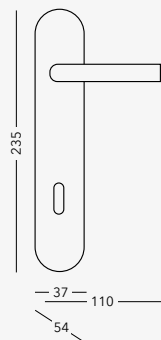

	CZK	bez DPH	s DPH
BB/PZ	665,0	665,0	804,7
WC	820,0	820,0	992,2
PZ-LI/RE	905,0	905,0	1095,1
	EUR	bez DPH	s DPH
BB/PZ	25,9	25,9	31,1
WC	32,1	32,1	38,5
PZ-LI/RE	35,4	35,4	42,5

OLV OFS OC ONS OCS  
K OV

# Element

200 tis.

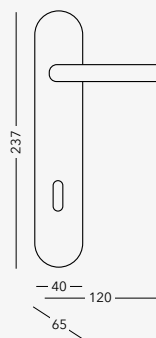

	CZK	bez DPH	s DPH
BB/PZ	795,0	795,0	962,0
WC	925,0	925,0	1119,3
PZ-LI/RE	990,0	990,0	1197,9
	EUR	bez DPH	s DPH
BB/PZ	31,2	31,2	37,4
WC	36,2	36,2	43,4
PZ-LI/RE	38,7	38,7	46,4

ONS F9 F4

# Element-R

200 tis. KR

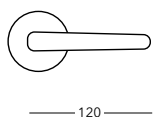

	CZK	bez DPH	s DPH
BB/PZ	795,0	795,0	962,0
WC	925,0	925,0	1119,3
PZ-LI/RE	990,0	990,0	1197,9
	EUR	bez DPH	s DPH
BB/PZ	31,2	31,2	37,4
WC	36,2	36,2	43,4
PZ-LI/RE	38,7	38,7	46,4

ONS

# Elsa-S

PR

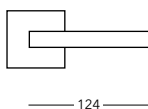

	CZK	bez DPH	s DPH
BB/PZ	850,0	850,0	1028,5
WC	1100,0	1100,0	1331,0
	EUR	bez DPH	s DPH
BB/PZ	33,3	33,3	40,0
WC	43,0	43,0	51,6

OCS ONS

## Esme-S

AW PR

🔑	<b>CZK</b>	bez DPH	s DPH
	BB/PZ	850,0	1028,5
	WC	1100,0	1331,0
🔑	<b>EUR</b>	bez DPH	s DPH
	BB/PZ	33,3	40,0
	WC	43,0	51,6

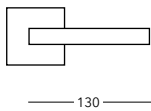

OCS ONS

## Fap

AW 200 tis.

🔑	<b>CZK</b>	bez DPH	s DPH
	BB/PZ	500,0	605,0
	WC	630,0	762,3
🔑	PZ-LI/RE	700,0	847,0
🔑	<b>EUR</b>	bez DPH	s DPH
	BB/PZ	19,5	23,4
	WC	24,5	29,4
🔑	PZ-LI/RE	27,4	32,9

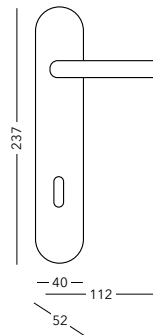

ONS

## Fap-R

AW 200 tis. KR

🔑	<b>CZK</b>	bez DPH	s DPH
	BB/PZ	605,0	732,1
	WC	735,0	889,4
🔑	PZ-LI/RE	795,0	962,0
🔑	<b>EUR</b>	bez DPH	s DPH
	BB/PZ	23,7	28,4
	WC	28,7	34,4
🔑	PZ-LI/RE	31,2	37,4

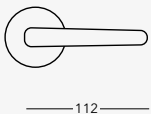

ONS

## Laura

AW 200 tis.

🔑	<b>CZK</b>	bez DPH	s DPH
	BB/PZ	490,0	592,9
	WC	605,0	732,1
🔑	PZ-LI/RE	670,0	810,7
🔑	<b>EUR</b>	bez DPH	s DPH
	BB/PZ	19,1	22,9
	WC	23,7	28,4
🔑	PZ-LI/RE	26,2	31,4

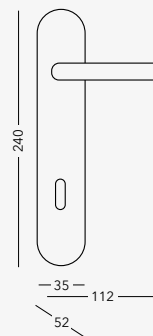

ONS OCS OC OFS OLV

## Laura-R

AW 200 tis. KR

🔑	<b>CZK</b>	bez DPH	s DPH
	BB/PZ	575,0	695,8
	WC	700,0	847,0
🔑	PZ-LI/RE	755,0	913,6
🔑	<b>EUR</b>	bez DPH	s DPH
	BB/PZ	22,4	26,9
	WC	27,4	32,9
🔑	PZ-LI/RE	29,5	35,4

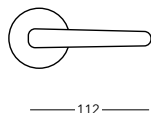

ONS OCS OC OLV OFS

ECO

## Milena

AW 200 tis.

🔑	<b>CZK</b>	bez DPH	s DPH
	BB/PZ	435,0	526,4
	WC	575,0	695,8
🔑	PZ-LI/RE	630,0	762,3
🔑	<b>EUR</b>	bez DPH	s DPH
	BB/PZ	17,0	20,5
	WC	22,4	26,9
🔑	PZ-LI/RE	23,1	27,8

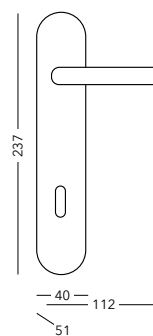

ONS OCS OFS

# Milena-R

200 tis. KR

<b>CZK</b>		bez DPH	s DPH
BB/PZ	460,0	556,6	
WC	590,0	713,9	
PZ-LI/RE	650,0	786,5	
<b>EUR</b>		bez DPH	s DPH
BB/PZ	18,0	21,6	
WC	23,1	27,8	
PZ-LI/RE	25,5	30,6	

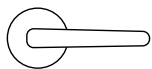

— 112 —



— 52 —  
— 51 —



ONS OCS IN

# Omega-S

200 tis. KR

<b>CZK</b>		bez DPH	s DPH
BB/PZ	1170,0	1416,0	
WC	1380,0	1670,0	
<b>EUR</b>		bez DPH	s DPH
BB/PZ	54,1	65,5	
WC	54,1	65,5	

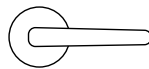

— 115 —



— 52 —  
— 57 —



ONS Cerná

# Orion

200 tis.

<b>CZK</b>		bez DPH	s DPH
BB/PZ	555,0	671,6	
WC	690,0	834,9	
PZ-LI/RE	745,0	901,5	
<b>EUR</b>		bez DPH	s DPH
BB/PZ	21,6	25,9	
WC	27,0	32,4	
PZ-LI/RE	29,1	34,9	

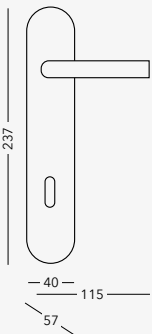

ONS OCS

# Orion-R

200 tis. KR

<b>CZK</b>		bez DPH	s DPH
BB/PZ	595,0	720,0	
WC	735,0	889,4	
PZ-LI/RE	785,0	949,9	
<b>EUR</b>		bez DPH	s DPH
BB/PZ	23,3	27,9	
WC	28,7	34,4	
PZ-LI/RE	30,8	36,9	



— 115 —



— 52 —  
— 57 —



ONS OCS





## Q-arte

200 tis.

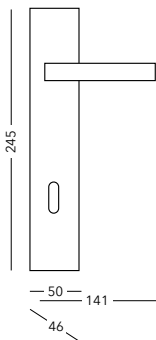

ONS OCS



CZK		bez DPH	s DPH
🔑	BB/PZ	1600,0	1936,0
	WC	1920,0	2323,2
🔑	PZ-LI/RE	2080,0	2516,8
EUR		bez DPH	s DPH
🔑	BB/PZ	62,7	75,3
	WC	75,3	90,4
🔑	PZ-LI/RE	81,6	97,9

## Q-arte-S

200 tis. KR



—141—



—50—  
50

ONS OCS



CZK		bez DPH	s DPH
🔑	BB/PZ	1490,0	1802,9
	WC	1790,0	2165,9
EUR		bez DPH	s DPH
🔑	BB/PZ	58,4	70,1
	WC	70,2	84,2

## Spring-S

200 tis. PR



—125—



—52—  
59

OCS ONS



CZK		bez DPH	s DPH
🔑	BB/PZ	1260,0	1524,6
	WC	1365,0	1651,7
EUR		bez DPH	s DPH
🔑	BB/PZ	49,4	59,3
	WC	53,5	64,2

## Vega-S

KR ++



—144—



—51—  
53

Cerná ONS



CZK		bez DPH	s DPH
🔑	BB/PZ	1170,0	1415,7
	WC	1380,0	1669,8
EUR		bez DPH	s DPH
🔑	BB/PZ	45,9	55,5
	WC	54,1	65,5

## Vera-S

KR ++

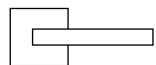

—130—



—54—  
60

ONS OFS Cerná



CZK		bez DPH	s DPH
🔑	BB/PZ	480,0	580,8
	WC	555,0	671,6
EUR		bez DPH	s DPH
🔑	BB/PZ	18,8	22,8
	WC	21,8	26,3

## Zeus

200 tis.

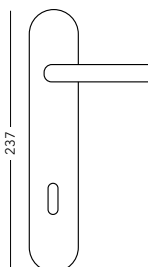

—40— 115  
59

ONS



CZK		bez DPH	s DPH
🔑	BB/PZ	405,0	490,1
	WC	520,0	629,2
🔑	PZ-LI/RE	575,0	695,8
EUR		bez DPH	s DPH
🔑	BB/PZ	15,9	19,2
	WC	20,4	24,7
🔑	PZ-LI/RE	22,5	27,3

# Zeus-R III

200 tis. PR

<b>CZK</b>	bez DPH	s DPH
BB/PZ	425,0	514,3
WC	555,0	671,6
PZ-LI/RE	630,0	762,3
<b>EUR</b>	bez DPH	s DPH
BB/PZ	16,7	20,2
WC	21,8	26,3
PZ-LI/RE	24,7	29,9

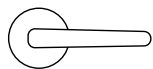

— 115 —



— 52 —

— 57 —



ONS

# Zoe-R

200 tis. KR

<b>CZK</b>	bez DPH	s DPH
BB/PZ	435,0	526,4
WC	500,0	605,0
<b>EUR</b>	bez DPH	s DPH
BB/PZ	17,1	20,6
WC	19,6	23,7

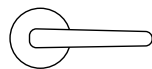

— 146 —



— 52 —

— 59 —



ONS OFS IN Černá

# 865

KR 1 mil.

<b>CZK</b>	bez DPH	s DPH
BB/PZ	1290,0	1560,9
WC	1610,0	1948,1
<b>EUR</b>	bez DPH	s DPH
BB/PZ	50,6	61,2
WC	63,1	76,4

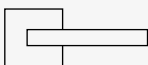

— 140 —



— 50 —

— 65 —



ONS OCS Černá

# 1085

1 mil. KR

<b>CZK</b>	bez DPH	s DPH
BB/PZ	1590,0	1923,9
WC	1810,0	2190,1
<b>EUR</b>	bez DPH	s DPH
BB/PZ	62,4	75,4
WC	71,0	85,9

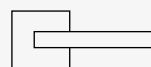

— 140 —



— 50 —

— 65 —



OCS ONS MA

# 1115

1 mil. KR

<b>CZK</b>	bez DPH	s DPH
BB/PZ	1490,0	1802,9
WC	1810,0	2190,1
<b>EUR</b>	bez DPH	s DPH
BB/PZ	58,4	70,7
WC	71,0	85,9

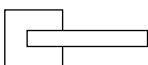

— 140 —



— 50 —

— 60 —



OCS ONS MA

# 1145

KR 1 mil.

<b>CZK</b>	bez DPH	s DPH
BB/PZ	1500,0	1815,0
WC	1610,0	1948,1
<b>EUR</b>	bez DPH	s DPH
BB/PZ	58,8	71,2
WC	63,1	76,4



— 140 —



— 50 —

— 65 —



ONS OCS

**1495**

W KR 1 mil.

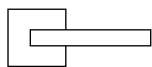

— 130,7 —



— 50 —

64

ONS OCS OC

	CZK	bez DPH	s DPH
🔑 BB/PZ		960,0	1161,6
WC		1290,0	1560,9
🔑 BB/PZ	EUR	bez DPH	s DPH
WC		37,6	45,6
		50,6	61,2

**1555**

W KR 1 mil.

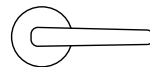

— 145 —



— 50 —

51

ONS OCS NIN

	CZK	bez DPH	s DPH
🔑 BB/PZ		1720,0	2081,2
WC		2040,0	2468,4
🔑 BB/PZ	EUR	bez DPH	s DPH
WC		67,5	80,9
		80,0	96,8



## Koule pevná Victory

KR ++

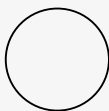

— Ø 52 —

59



	CZK	bez DPH	s DPH
cena ks		480,0	580,8
cena ks	EUR	bez DPH	s DPH
		18,8	22,8

OCS ONS OCN OFS Černá

Samostatná koule bez rozety na vyžádání.  
Zeptejte se na možnost otočných variant.

### ČESKÁ FIRMA

Za našimi produkty a službami stojí bohaté zkušenosti a práce zaměstnanců stabilní české firmy. Pověstná zručnost a velké zkušenosti českých pracovníků jsou tak základem kvality a spolehlivosti výrobků značky COBRA.

### TRADICE OD ROKU 1991

Jsmeme již 30let na trhu - od roku 1991 - a máme díky tomu bohaté zkušenosti. Známe potřeby našich zákazníků a trendy v oboru. To nám umožňuje neustále přinášet stále to nejlepší v našich výrobcích a službách.

[www.matekliku.cz](http://www.matekliku.cz)

### CZECH COMPANY

Valuable experiences and work of our employees that is what lies behind products and services of COBRA. Reputation of having great skills and also experiences of our czech employees are the foundations of quality and reliability of COBRA products.

### THIRTY YEARS OF TRADITION

We have thirty years of experience on interior design and door fittings market. We are aware of our customers' needs as well as the needs of architects and developers. Having this experience enables us to keep bringing the best in our products and services.

[www.matekliku.cz](http://www.matekliku.cz)



# ČERNÁ TITAN

## Černá / Titan

BLACK / TITANIUM

70	Aphrodité-S	71	Omega-S	72	1495
70	Athena-S	71	Vega-S	72	1555
70	Gaja-S	71	Vera-S	72	Koule pevná Victory
70	Gabri-S	71	Vision-R III		
70	Gussy-R	71	Zoe-R		
70	Linda-S	71	865		



**Nebojte se výrazného a netradičního řešení - elegantní černá klika v kombinaci s dalšími vhodně zvolenými prvky interiéru působí nejen luxusně, ale i velmi nadčasově.**

Do not be afraid of a distinctive and unconventional solution – elegant black handle in combination with an additional chosen elements of the interior can not only be luxurious but also very timeless.



## Aphrodité-S

200 tis. KR

	CZK	bez DPH	s DPH
BB/PZ	605,0		732,1
WC	690,0		834,9
<b>EUR</b>			
BB/PZ	23,7		28,7
WC	27,1		32,7

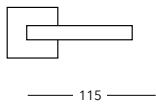

Titan ONS Černá



## Athena-S

200 tis. KR

	CZK	bez DPH	s DPH
BB/PZ	500,0		605,0
WC	630,0		762,3
<b>EUR</b>			
BB/PZ	19,6		23,7
WC	24,7		29,9

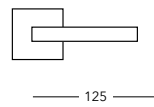

Titan ONS

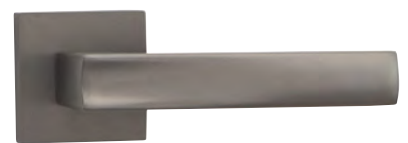

## Gaia-S

200 tis.

	CZK	bez DPH	s DPH
BB/PZ	855,0		1034,6
WC	925,0		1119,3
<b>EUR</b>			
BB/PZ	33,5		40,6
WC	36,3		43,9

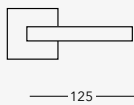

Černá IN



## Gabri-S

200 tis.

	CZK	bez DPH	s DPH
BB/PZ	670,0		810,7
WC	755,0		913,6
<b>EUR</b>			
BB/PZ	26,3		31,8
WC	29,6		35,8

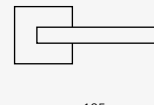

Černá OCN



## Giussy-R

200 tis.

	CZK	bez DPH	s DPH
BB/PZ	820,0		992,2
WC	900,0		1089,0
<b>EUR</b>			
BB/PZ	32,2		38,9
WC	35,3		42,7

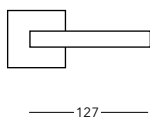

Černá IN OCN OFS



## Linda-S

KR

	CZK	bez DPH	s DPH
BB/PZ	945,0		1143,5
WC	1075,0		1300,8
<b>EUR</b>			
BB/PZ	37,1		44,8
WC	42,2		51,0

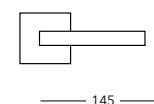

Černá



## Omega-S

<b>CZK</b>	bez DPH	s DPH
🔑 BB/PZ	1170,0	1416,0
WC	1380,0	1670,0
<b>EUR</b>	bez DPH	s DPH
🔑 BB/PZ	45,9	55,5
WC	54,1	65,5

200 tis.

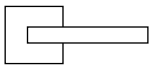

— 144 —



— 52 —  
— 50 —

Cerná ONS



## Vega-S

<b>CZK</b>	bez DPH	s DPH
🔑 BB/PZ	1170,0	1416,0
WC	1380,0	1670,0
<b>EUR</b>	bez DPH	s DPH
🔑 BB/PZ	45,9	55,5
WC	54,1	65,5

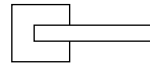

— 144 —



— 51 —  
— 53 —

Cerná ONS



## Vera-S

<b>CZK</b>	bez DPH	s DPH
🔑 BB/PZ	575,0	695,8
WC	650,0	786,5
<b>EUR</b>	bez DPH	s DPH
🔑 BB/PZ	22,5	27,3
WC	25,5	30,8

200 tis. KR

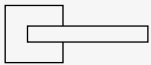

— 140 —



— 50 —  
— 65 —

Cerná ONS OFS



## Vision-R III

<b>CZK</b>	bez DPH	s DPH
🔑 BB/PZ	645,0	780,5
WC	815,0	986,2
<b>EUR</b>	bez DPH	s DPH
🔑 BB/PZ	25,3	30,6
WC	32,0	38,7

200 tis. KR

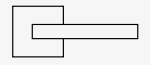

— 145 —



— 50 —  
— 52 —

Cerná IN



## Zoe-R

<b>CZK</b>	bez DPH	s DPH
🔑 BB/PZ	545,0	659,5
WC	605,0	732,1
<b>EUR</b>	bez DPH	s DPH
🔑 BB/PZ	21,4	25,9
WC	23,7	28,7

200 tis. KR



— 140 —



— 50 —  
— 65 —

Cerná OFS ONS IN



## 865

<b>CZK</b>	bez DPH	s DPH
🔑 BB/PZ	1290,0	1560,9
WC	1610,0	1948,1
<b>EUR</b>	bez DPH	s DPH
🔑 BB/PZ	50,6	60,7
WC	63,1	75,8

1 mil. KR

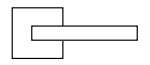

— 140 —



— 50 —  
— 65 —

Cerná OCS ONS





**1495**

1 mil. KR



— 131 —



— 50 —

52

Černá OCS ONS OC

CZK	bez DPH	s DPH
BB/PZ	1050,0	1270,5
WC	1410,0	1706,1
EUR	bez DPH	s DPH
BB/PZ	41,2	49,4
WC	55,3	66,4

**1555**

1 mil. KR



— 145 —



— 50 —

52

Černá OCS ONS

CZK	bez DPH	s DPH
BB/PZ	1720,0	2081,2
WC	2040,0	2468,4
EUR	bez DPH	s DPH
BB/PZ	67,5	80,9
WC	80,0	96,0



## Koule pevná Victory

KR

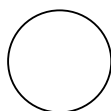

— Ø 52 —

59



OCS ONS OCN OFS Černá

Samostatná koule bez rozety na vyžádání.  
Zeptejte se na možnost otočných variant.

# COBRA®



Black / Titanium



# OCN

## Chrom lesklý / Nikl matný

POLISHED CHROME / SATIN NICKEL

76 Gabri  
76 Gabri-R  
76 Gabri-S  
76 Gussy-R  
76 Nicol-R  
76 Nicol-S

77 Sharon-R  
77 Vanda-R  
  
77 Koule pevná  
Victory



**Kombinované kliky představují skutečnou designovou lahůdku. Spojení lesklého chromu a matného niklu představuje unikátní řešení, spojující dva designové materiály do jednoho oku lahodícího funkčního celku.**

Combined handles represent a real design delicacy. Merging of glossy chrome and frostal nickel is a unique solution joining two design materials into one nice-looking functional single unit.



## Gabri

200 tis.

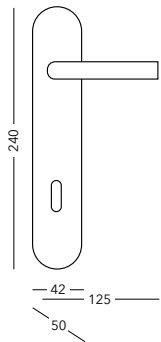

OCN



	CZK	bez DPH	s DPH
🔑 BB/PZ		595,0	720,0
WC		870,0	1052,7
🔑 PZ-LI/RE		820,0	992,2
<b>EUR</b>			
🔑 BB/PZ		23,3	28,2
WC		34,1	41,3
🔑 PZ-LI/RE		32,2	38,9

## Gabri-S

200 tis. KR

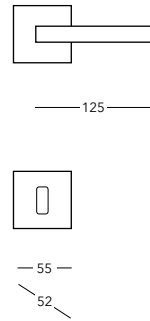

OCN Černá



	CZK	bez DPH	s DPH
🔑 BB/PZ		595,0	720,0
WC		870,0	1052,7
🔑 PZ-LI/RE		1085,0	1312,9
<b>EUR</b>			
🔑 BB/PZ		23,3	28,2
WC		34,1	41,3
🔑 PZ-LI/RE		42,5	51,5

## Gabri-R

200 tis. KR

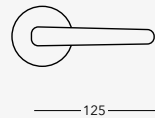

OCN



	CZK	bez DPH	s DPH
🔑 BB/PZ		595,0	720,0
WC		850,0	1028,5
🔑 PZ-LI/RE		850,0	1028,5
<b>EUR</b>			
🔑 BB/PZ		22,2	26,8
WC		33,3	40,3
🔑 PZ-LI/RE		33,3	40,3

## Giusy-R

200 tis. KR

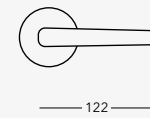

IN OCN OFS Černá



	CZK	bez DPH	s DPH
🔑 BB/PZ		595,0	720,0
WC		870,0	1052,7
🔑 PZ-LI/RE		945,0	1143,5
<b>EUR</b>			
🔑 BB/PZ		23,3	28,2
WC		34,1	41,3
🔑 PZ-LI/RE		37,1	44,8

## Nicol-R

200 tis. PR

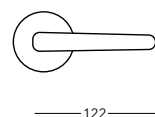

OCN



	CZK	bez DPH	s DPH
🔑 BB/PZ		560,-	678,-
WC		745,0	901,5
🔑 PZ-LI/RE		945,0	1143,5
<b>EUR</b>			
🔑 BB/PZ		23,3	28,2
WC		29,2	35,4
🔑 PZ-LI/RE		37,1	44,8

## Nicol-S

200 tis. KR

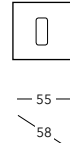
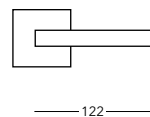

OCN



	CZK	bez DPH	s DPH
🔑 BB/PZ		670,0	810,7
WC		880,0	1064,8
🔑 PZ-LI/RE		1075,0	1300,8
<b>EUR</b>			
🔑 BB/PZ		26,3	31,8
WC		34,5	41,8
🔑 PZ-LI/RE		42,2	51,0

## Sharon-R

200 tis. KR

CZK		bez DPH	s DPH
BB/PZ	690,0	690,0	834,9
WC	840,0	840,0	1016,4
PZ-LI/RE	905,0	905,0	1095,1
EUR		bez DPH	s DPH
BB/PZ	27,1	27,1	32,7
WC	32,9	32,9	39,9
PZ-LI/RE	35,5	35,5	42,9

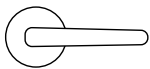

— 135 —



— 52 —

68

OCN



## Vanda-R

200 tis. KR

CZK		bez DPH	s DPH
BB	480,0	480,0	580,8
WC	555,0	555,0	671,6
LI/RE	670,0	670,0	810,7
EUR		bez DPH	s DPH
BB	18,8	18,8	22,8
WC	21,8	21,8	26,3
LI/RE	26,3	26,3	31,8

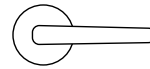

— 120 —



— 52 —

60

OCN



## Koule pevná Victory

200 tis. KR

CZK		bez DPH	s DPH
cena ks	480,0	480,0	580,8
EUR		bez DPH	s DPH
cena ks	18,8	18,8	22,8
obj. číslo	C415917602		

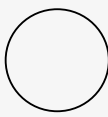

— Ø 52 —

59



OCS ONS OCN OFS

Samostatná koule bez rozety na vyžádání. Varianty provedení levá, pravá, pevná, otočná.



# COBRA

## Bronz česaný

### BRUSHED BRASS

80	Alt-Wien	81	Kristina	82	Venezia
80	Atlantis	81	Kristina-R	82	Vera-S
80	Dea	81	Laura	83	Zoe-R
80	Dea-R	81	Laura-R		
80	Elegant	82	Milena	83	Koule pevná
80	Florence	82	Münster		Victory
81	Giussy-R	82	Sina		
81	Ikarus	82	Sina-R		



Česaný bronz díky své jedinečné barevnosti a struktuře patří mezi nejklašičtější výrobky COBRA. Dveřní kování v tradičních i moderních tvarech působí zcela unikátně, doslova číší tajemnem starých časů.

Thanks to its unique variety of colour and its structure. Brushed brass is one of COBRA's classic products thanks to its unique variety of colour and structure. Door fittings in traditional and modern shapes look very unique literally overflowing with old time's mystery.





## Alt-Wien

**200 tis.**

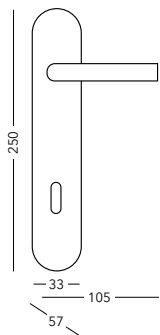

OLV OFS OC ONS OCS  
K OV



CZK		bez DPH	s DPH
🔑	BB/PZ	725,0	877,3
	WC	895,0	1083,0
🔑	PZ-LI/RE	980,0	1185,8
EUR		bez DPH	s DPH
🔑	BB/PZ	28,4	34,4
	WC	35,1	42,5
🔑	PZ-LI/RE	38,4	46,5

## Atlantis

**200 tis.**

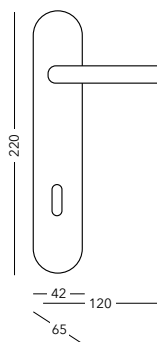

OLV OFS K



CZK		bez DPH	s DPH
🔑	BB/PZ	1020,0	1234,2
	WC	1145,0	1385,5
🔑	PZ-LI/RE	1210,0	1464,1
EUR		bez DPH	s DPH
🔑	BB/PZ	40,0	48,4
	WC	44,9	54,3
🔑	PZ-LI/RE	47,5	57,4

## Dea

**200 tis.**

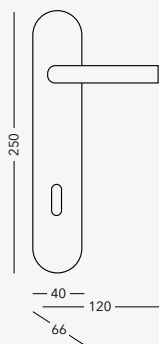

OFS



CZK		bez DPH	s DPH
🔑	BB/PZ	755,0	913,6
	WC	880,0	1064,8
🔑	PZ-LI/RE	955,0	1155,6
EUR		bez DPH	s DPH
🔑	BB/PZ	29,6	35,8
	WC	34,5	41,8
🔑	PZ-LI/RE	37,5	45,3

## Dea-R

**200 tis.** KR

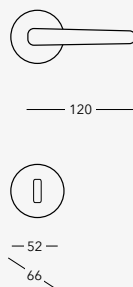

OFS



CZK		bez DPH	s DPH
🔑	BB/PZ	820,0	992,2
	WC	955,0	1155,6
🔑	PZ-LI/RE	1010,0	1222,1
EUR		bez DPH	s DPH
🔑	BB/PZ	32,2	38,9
	WC	37,5	45,3
🔑	PZ-LI/RE	39,6	47,9

## Elegant

**200 tis.**

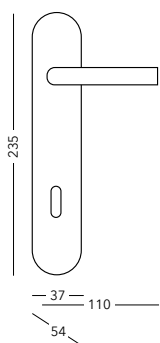

OLV OFS OC ONS OCS  
K OV



CZK		bez DPH	s DPH
🔑	BB/PZ	600,0	726,0
	WC	770,0	931,7
🔑	PZ-LI/RE	840,0	1016,4
EUR		bez DPH	s DPH
🔑	BB/PZ	23,5	28,5
	WC	30,2	36,5
🔑	PZ-LI/RE	32,9	39,9

## Florence

**200 tis.**

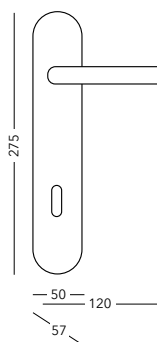

OFS



CZK		bez DPH	s DPH
🔑	BB/PZ	1000,0	1210,0
	WC	1125,0	1361,3
🔑	PZ-LI/RE	1190,0	1439,9
EUR		bez DPH	s DPH
🔑	BB/PZ	39,2	47,5
	WC	44,1	53,4
🔑	PZ-LI/RE	46,7	56,5

# Giussy-R

200 tis. KR

	CZK	bez DPH	s DPH
BB/PZ	595,0	595,0	720,0
WC	870,0	870,0	1052,7
PZ-LI/RE	945,0	945,0	1143,5
	EUR	bez DPH	s DPH
BB/PZ	23,3	23,3	28,2
WC	34,1	34,1	41,3
PZ-LI/RE	37,1	37,1	44,8

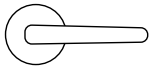

—122—



—52—  
68



IN OFS OCN F1 F4

# Ikarus

200 tis.

	CZK	bez DPH	s DPH
BB/PZ	725,0	725,0	877,3
WC	960,0	960,0	1161,6
PZ-LI/RE	1040,0	1040,0	1258,4
	EUR	bez DPH	s DPH
BB/PZ	28,4	28,4	34,4
WC	37,6	37,6	45,6
PZ-LI/RE	40,8	40,8	49,3

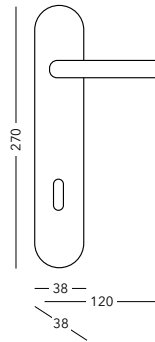

270

—38— 120  
38



OLV OFS

# Kristina

200 tis.

	CZK	bez DPH	s DPH
BB/PZ	545,0	545,0	659,5
WC	670,0	670,0	810,7
PZ-LI/RE	735,0	735,0	889,4
	EUR	bez DPH	s DPH
BB/PZ	21,4	21,4	25,9
WC	26,3	26,3	31,8
PZ-LI/RE	28,8	28,8	34,9

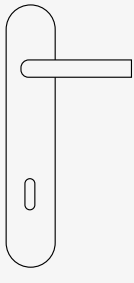

—40— 108  
49



OFS OLV

# Kristina-R

200 tis. KR

	CZK	bez DPH	s DPH
BB/PZ	615,0	615,0	744,2
WC	745,0	745,0	901,5
PZ-LI/RE	810,0	810,0	980,1
	EUR	bez DPH	s DPH
BB/PZ	24,1	24,1	29,2
WC	29,2	29,2	35,4
PZ-LI/RE	31,8	31,8	38,4

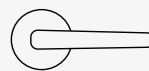

—108—



—52—  
49



OLV OFS

# Laura

200 tis.

	CZK	bez DPH	s DPH
BB/PZ	490,0	490,0	592,9
WC	605,0	605,0	732,1
PZ-LI/RE	670,0	670,0	810,7
	EUR	bez DPH	s DPH
BB/PZ	19,2	19,2	23,3
WC	23,7	23,7	28,7
PZ-LI/RE	26,3	26,3	31,8

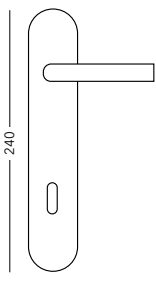

240

—35— 112  
52



ONS OCS OC OLV OFS

# Laura-R

200 tis. KR

	CZK	bez DPH	s DPH
BB/PZ	575,0	575,0	695,8
WC	700,0	700,0	847,0
PZ-LI/RE	755,0	755,0	913,6
	EUR	bez DPH	s DPH
BB/PZ	22,5	22,5	27,3
WC	27,5	27,5	33,2
PZ-LI/RE	29,6	29,6	35,8

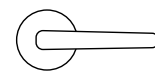

—112—



—52—  
54



ONS OCS OC OLV OFS

## Milena

200 tis.

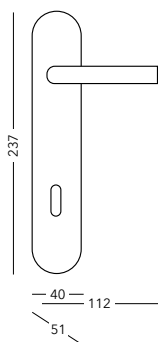

ONS OCS OFS



	CZK	bez DPH	s DPH
🔑	BB/PZ	435,0	526,4
	WC	575,0	695,8
🔑	PZ-LI/RE	630,0	762,3
	EUR	bez DPH	s DPH
🔑	BB/PZ	17,1	20,6
	WC	22,5	27,3
🔑	PZ-LI/RE	24,7	29,9

## Münster

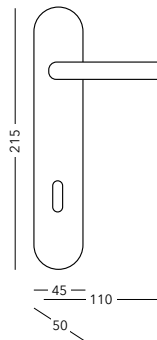

OLV OFS



	CZK	bez DPH	s DPH
🔑	BB/PZ	425,0	514,3
	WC	555,0	671,6
🔑	PZ-LI/RE	615,0	744,2
	EUR	bez DPH	s DPH
🔑	BB/PZ	16,7	20,2
	WC	21,8	26,3
🔑	PZ-LI/RE	24,1	29,2

## Sina

200 tis.

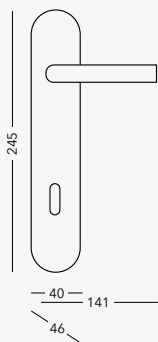

OFS ONS



	CZK	bez DPH	s DPH
🔑	BB/PZ	615,0	744,2
	WC	745,0	901,5
🔑	PZ-LI/RE	810,0	980,1
	EUR	bez DPH	s DPH
🔑	BB/PZ	24,1	29,2
	WC	29,2	35,4
🔑	PZ-LI/RE	31,8	38,4

## Sina-R

200 tis. KR

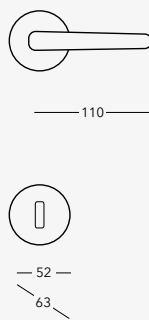

ONS OFS

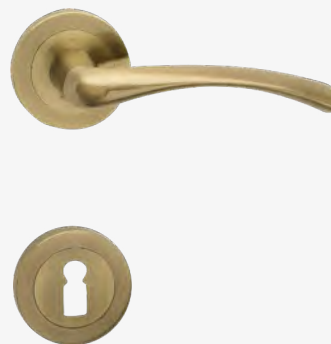

	CZK	bez DPH	s DPH
🔑	BB/PZ	810,0	980,1
	WC	945,0	1143,5
🔑			
	EUR	bez DPH	s DPH
🔑	BB/PZ	31,8	38,4
	WC	37,1	44,8
🔑			

## Venezia

200 tis.

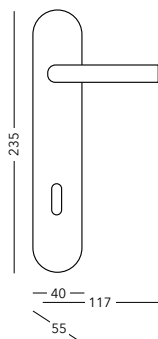

OFS K



	CZK	bez DPH	s DPH
🔑	BB/PZ	615,0	744,2
	WC	745,0	901,5
🔑	PZ-LI/RE	810,0	980,1
	EUR	bez DPH	s DPH
🔑	BB/PZ	24,1	29,2
	WC	29,2	35,4
🔑	PZ-LI/RE	31,8	38,4

## Vera-S

200 tis. KR

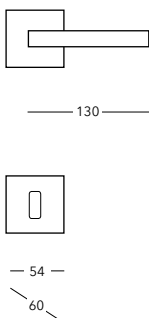



ONS OFS Černá



	CZK	bez DPH	s DPH
🔑	BB/PZ	480,0	580,8
	WC	555,0	671,6
🔑			
	EUR	bez DPH	s DPH
🔑	BB/PZ	18,8	22,8
	WC	21,8	26,3
🔑			

## Zoe-R

 200 tis.
  KR

	CZK	bez DPH	s DPH
 BB/PZ		435,0	526,4
WC		500,0	605,0
 EUR		bez DPH	s DPH
BB/PZ		17,1	20,6
WC		19,6	23,7

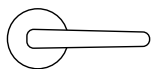

— 146 —



— 52 —

59

Koule pevná  
Victory
 KR

	CZK	bez DPH	s DPH
cena ks		480,0	580,8
		bez DPH	s DPH
cena ks		18,8	22,8

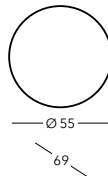

— Ø 55 —

69



Samostatná koule bez rozety na vyžádání.  
Variety provedení levá, pravá, pevná, otočná.

# COBRA®



# COLVW

## Mosaz leštěná

POLISHED BRASS

86 Alt-Wien  
86 Atlantis  
86 Elegant

86 Ikarus  
86 Kristina  
86 Kristina-R

87 Laura  
87 Laura-R  
87 Münster



**Mosazné kliky strojně leštíme, abychom dosáhli nejvyššího lesku. Při zpracování klademe nejvyšší nároky na kvalitu, zlatý vzhled kliky totiž nesnese sebemenší chybu v lesku.**

Brass handles are mechanically polished in order to reach the best shine possible. During processing we place emphasis on quality. The golden appearance of the handle does not pardon even the smallest defect on the gloss.



## Alt-Wien

**W** 200 tis.

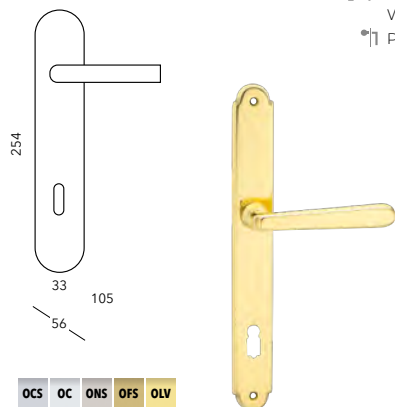

OCS OC ONS OFS OLV  
OV K

	CZK	bez DPH	s DPH
🔑 BB/PZ		725,0	877,3
🔑 WC		895,0	1083,0
🔑 PZ-LI/RE		980,0	1185,8
	EUR	bez DPH	s DPH
🔑 BB/PZ		28,4	34,4
🔑 WC		35,1	42,5
🔑 PZ-LI/RE		38,4	46,5

## Atlantis

**W** 200 tis.

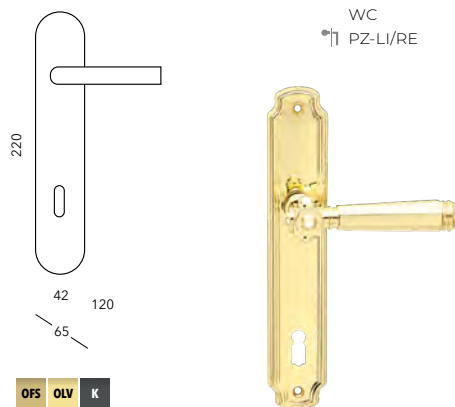

OFS OLV K

	CZK	bez DPH	s DPH
🔑 BB/PZ		1020,0	1234,2
🔑 WC		1145,0	1385,5
🔑 PZ-LI/RE		1210,0	1464,1
	EUR	bez DPH	s DPH
🔑 BB/PZ		40,0	48,4
🔑 WC		44,9	54,3
🔑 PZ-LI/RE		47,5	57,4

## Elegant

**W** 200 tis.

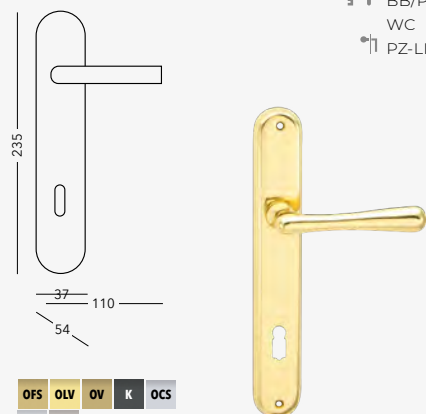

OFS OLV OV K OCS  
OC ONS

	CZK	bez DPH	s DPH
🔑 BB/PZ		600,0	726,0
🔑 WC		770,0	931,7
🔑 PZ-LI/RE		840,0	1016,4
	EUR	bez DPH	s DPH
🔑 BB/PZ		23,5	28,5
🔑 WC		30,2	36,5
🔑 PZ-LI/RE		32,9	39,9

## Ikarus

**W** 200 tis.

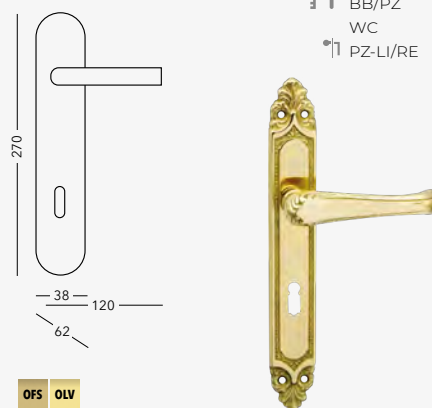

OFS OLV

	CZK	bez DPH	s DPH
🔑 BB/PZ		725,0	877,3
🔑 WC		960,0	1161,6
🔑 PZ-LI/RE		1040,0	1258,4
	EUR	bez DPH	s DPH
🔑 BB/PZ		28,4	34,4
🔑 WC		37,6	45,6
🔑 PZ-LI/RE		40,8	49,3

## Kristina

**W** 200 tis. PR

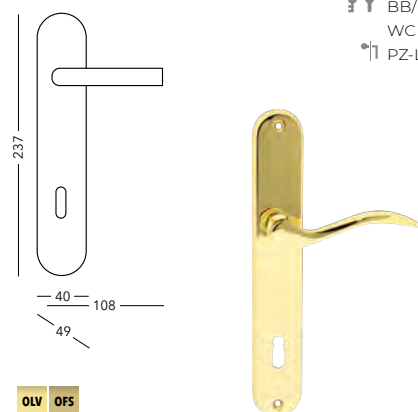

OLV OFS

	CZK	bez DPH	s DPH
🔑 BB/PZ		545,0	659,5
🔑 WC		670,0	810,7
🔑 PZ-LI/RE		735,0	889,4
	EUR	bez DPH	s DPH
🔑 BB/PZ		21,4	25,9
🔑 WC		26,3	31,8
🔑 PZ-LI/RE		28,8	34,9

## Kristina-R

**W** 200 tis. KR ++

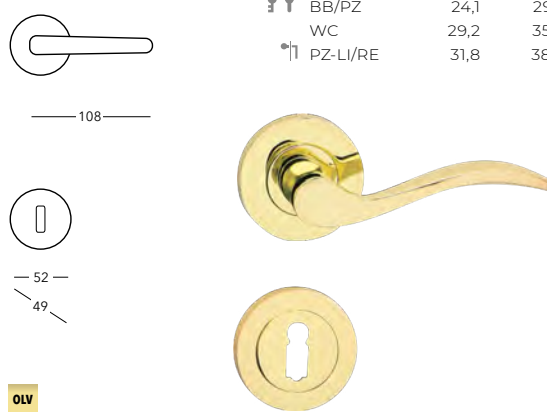

OLV

	CZK	bez DPH	s DPH
🔑 BB/PZ		615,0	744,2
🔑 WC		745,0	901,5
🔑 PZ-LI/RE		810,0	980,1
	EUR	bez DPH	s DPH
🔑 BB/PZ		24,1	29,2
🔑 WC		29,2	35,4
🔑 PZ-LI/RE		31,8	38,4

# Laura

200 tis.

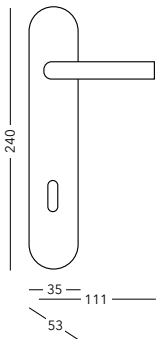

	CZK	bez DPH	s DPH
BB/PZ	490,0	490,0	592,9
WC	605,0	605,0	732,1
PZ-LI/RE	670,0	670,0	810,7
	EUR	bez DPH	s DPH
BB/PZ	19,2	19,2	23,3
WC	23,7	23,7	28,7
PZ-LI/RE	26,3	26,3	31,8



OCS OC ONS OFS OLV

# Laura-R

200 tis. KR



	CZK	bez DPH	s DPH
BB/PZ	575,0	575,0	695,8
WC	700,0	700,0	847,0
PZ-LI/RE	755,0	755,0	913,6
	EUR	bez DPH	s DPH
BB/PZ	22,5	22,5	27,3
WC	27,5	27,5	33,2
PZ-LI/RE	29,6	29,6	35,8



OCS OC ONS OFS OLV

# Münster

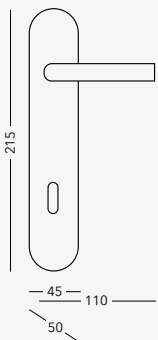

	CZK	bez DPH	s DPH
BB/PZ	425,0	425,0	514,3
WC	555,0	555,0	671,6
PZ-LI/RE	615,0	615,0	744,2
	EUR	bez DPH	s DPH
BB/PZ	16,7	16,7	20,2
WC	21,8	21,8	26,3
PZ-LI/RE	24,1	24,1	29,2



OFS OLV

# COBRA®





# OV

## Staromosaz

OLD BRASS

89 Alt-wien

89 Elegant

89 1115

89 1085



**Decentní matný vzhled staromosazných klik je krásný v kombinaci s tradičními prvky rustikálních interiérů. Klasika, to je ten správný výraz pro charakter staromosazných dveřních kování.**

Decent frostal look of ancient brass handles is very beautiful if put in combination with traditional elements of rustic-looking interiors. A "classic" that is the correct name for character of old brass door fittings.

## Alt-wien

**M** 200 tis.

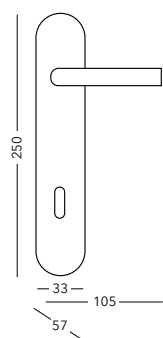

OCS OC ONS OFS OLV  
OV K



	CZK	bez DPH	s DPH
☞ BB/PZ	750,0	907,5	
☞ WC	915,0	1107,2	
☞ PZ-LI/RE	1000,0	1210,0	
	EUR	bez DPH	s DPH
☞ BB/PZ	29,4	35,6	
☞ WC	35,9	43,4	
☞ PZ-LI/RE	39,2	47,5	

## Elegant

**M** 200 tis.

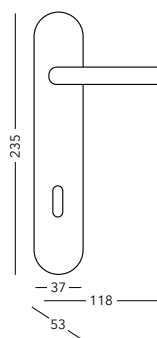

OCS OC ONS OFS OLV  
OV K



	CZK	bez DPH	s DPH
☞ BB/PZ	600,0	726,0	
☞ WC	770,0	931,7	
☞ PZ-LI/RE	840,0	1016,4	
	EUR	bez DPH	s DPH
☞ BB/PZ	23,5	28,5	
☞ WC	30,2	36,5	
☞ PZ-LI/RE	32,9	39,9	

## 1115

**M** 1 mil. KR

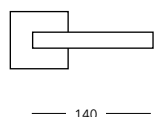

— 50 —  
— 60 —

MA OCS ONS



	CZK	bez DPH	s DPH
☞ BB/PZ	1590,0	1924,0	
☞ WC	1915,0	2317,0	
	EUR	bez DPH	s DPH
☞ BB/PZ	62,4	74,9	
☞ WC	75,0	90,0	

## 1085

**M** 1 mil. KR

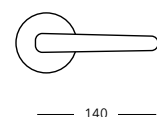

— 50 —  
— 65 —

MA OCS ONS



	CZK	bez DPH	s DPH
☞ BB/PZ	1700,0	2057,0	
☞ WC	1915,0	2317,0	
	EUR	bez DPH	s DPH
☞ BB/PZ	66,7	80,0	
☞ WC	75,0	90,0	



# Kované a rustikální kování

## FORGED HARDWARE

92	Alt-Wien	94	Hamburg	95	Venezia-R
92	Atlantis	94	Hamburg-R	96	Vienna-R+
92	Atlantis-R	94	Hamburg-R+		
92	Baden	94	Imst+	96	Koule pevná Bonn HR
92	Baden+	94	Imst-R		
92	Baden-S	94	Innsbruck	96	Koule pevná Linz HR
93	Baden-S+	95	Innsbruck-R		
93	Berlin	95	Regen		
93	Bremen	95	Salzburg		
93	Burg-R	95	Salzburg-S		
93	Elegant	95	Venezia		



**Kontrast surového kovu, kovářského řemesla a jedinečných designů přinese do vašich interiérů každodenní dotek s jedinečností. Vyberte si nejvhodnější design, kované kliky jsou vhodné do rustikálních i moderních bytů a domů.**

The contrast of crude metal, forger craft and unique designs will bring everyday touch with uniqueness into your interiors. Select the most appropriate design, forged handles are suitable for rural-looking as well as modern flats and houses.



## Alt-Wien

rustikální

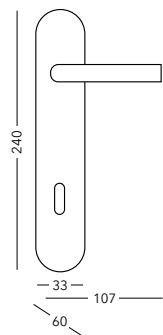

OCS OC ONS OFS OLV  
OV K



CZK		bez DPH	s DPH
	BB/PZ	755,0	913,6
	WC	925,0	1119,3
	PZ-LI/RE	1010,0	1222,1
EUR		bez DPH	s DPH
	BB/PZ	29,6	35,8
	WC	36,3	43,9
	PZ-LI/RE	39,6	47,9

## Atlantis

rustikální

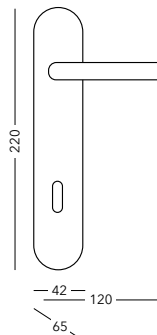

OFS OLV K



CZK		bez DPH	s DPH
	BB/PZ	795,0	962,0
	WC	1145,0	1385,5
	PZ-LI/RE	1210,0	1464,1
EUR		bez DPH	s DPH
	BB/PZ	31,2	37,7
	WC	44,9	54,3
	PZ-LI/RE	47,5	57,4

## Atlantis-R

rustikální

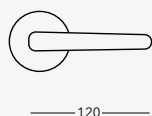

K



CZK		bez DPH	s DPH
	BB/PZ	850,0	1028,5
	WC	1200,0	1452,0
	PZ-LI/RE	1275,0	1542,8
EUR		bez DPH	s DPH
	BB/PZ	33,3	40,3
	WC	47,1	56,9
	PZ-LI/RE	50,0	60,5

## Baden

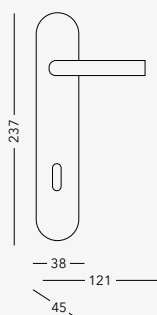

K



CZK		bez DPH	s DPH
	BB/PZ	3740,0	4525,4
	WC	4785,0	5789,9
	PZ-LI/RE	4210,0	5094,1
EUR		bez DPH	s DPH
	BB/PZ	146,7	177,5
	WC	165,1	199,8
	PZ-LI/RE	165,1	199,8

## Baden+

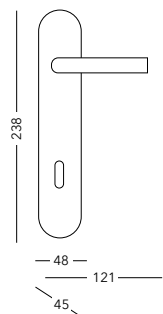

K



CZK		bez DPH	s DPH
	PZ-LI/RE	6200,0	7502,0
EUR		bez DPH	s DPH
	PZ-LI/RE	243,1	294,2

## Baden-S

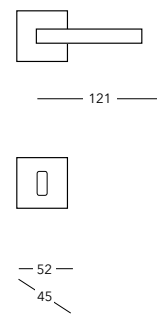

K



CZK		bez DPH	s DPH
	BB/PZ	3730,0	4513,3
	WC	4800,0	5808,0
EUR		bez DPH	s DPH
	BB/PZ	146,3	177,0
	WC	188,2	227,8

## Baden-S+

CZK	bez DPH	s DPH
🔑 PZ-LI/RE	5510,0	6667,1

EUR	bez DPH	s DPH
🔑 PZ-LI/RE	216,1	261,5

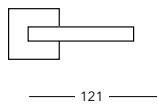

K



## Berlin

CZK	bez DPH	s DPH
🔑 BB/PZ	2705,0	3273,1
🔑 PZ-LI/RE	2820,0	3412,2

EUR	bez DPH	s DPH
🔑 BB/PZ	106,1	128,4
🔑 PZ-LI/RE	110,6	133,8

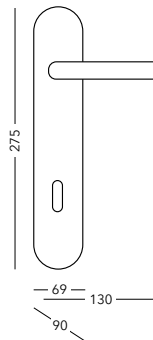

K



## Bremen

CZK	bez DPH	s DPH
🔑 BB/PZ	1350,0	1633,5
🔑 PZ-LI/RE	1680,0	2032,8

EUR	bez DPH	s DPH
🔑 BB/PZ	52,9	64,1
🔑 PZ-LI/RE	65,9	79,7

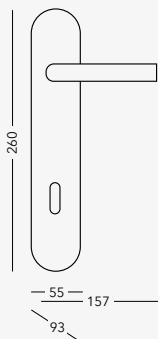

K



## Burg-R

CZK	bez DPH	s DPH
🔑 BB/PZ	3130,0	3787,3
WC	4110,0	4973,1

EUR	bez DPH	s DPH
🔑 BB/PZ	122,7	148,5
WC	161,2	195,0

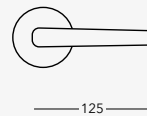

K

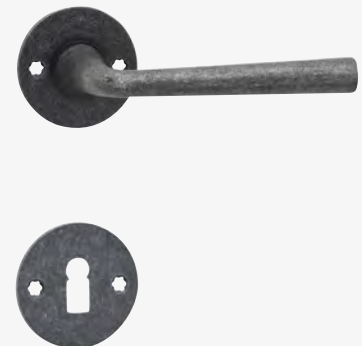

## Elegant

CZK	bez DPH	s DPH
🔑 BB/PZ	605,0	732,1
WC	775,0	937,8
🔑 PZ-LI/RE	850,0	1028,5

EUR	bez DPH	s DPH
🔑 BB/PZ	23,7	28,7
WC	30,4	36,8
🔑 PZ-LI/RE	33,3	40,3

rustikální

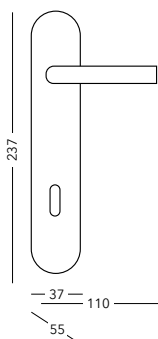

OFS OLV OV K



## Hamburg

<b>CZK</b>		bez DPH	s DPH
☞	BB/PZ	1955,0	2365,6
☞	PZ-LI/RE	2210,0	2674,1
<b>EUR</b>		bez DPH	s DPH
☞	BB/PZ	76,7	92,8
☞	PZ-LI/RE	86,7	104,9

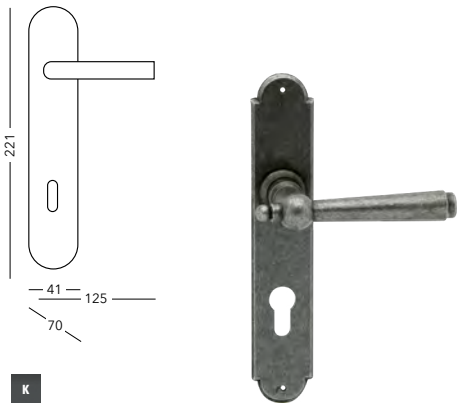

K

## Hamburg-R

<b>CZK</b>		bez DPH	s DPH
☞	BB/PZ	2165,0	2619,7
☞	WC	2430,0	2940,3
<b>EUR</b>		bez DPH	s DPH
☞	BB/PZ	84,9	102,7
☞	WC	95,3	115,3

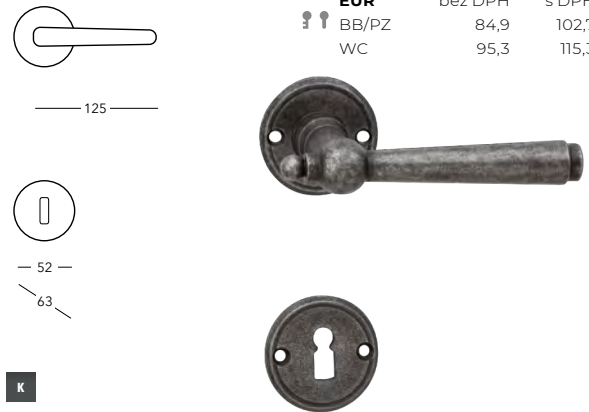

K

## Hamburg-R+

<b>CZK</b>		bez DPH	s DPH
☞	PZ	3305,0	3999,1
<b>EUR</b>		bez DPH	s DPH
☞	PZ	129,6	156,8



K

## Imst+

<b>CZK</b>		bez DPH	s DPH
☞	PZ	3740,0	4525,4
☞	PZ-LI/RE	3740,0	4525,4
<b>EUR</b>		bez DPH	s DPH
☞	PZ	146,7	177,5
☞	PZ-LI/RE	146,7	177,5

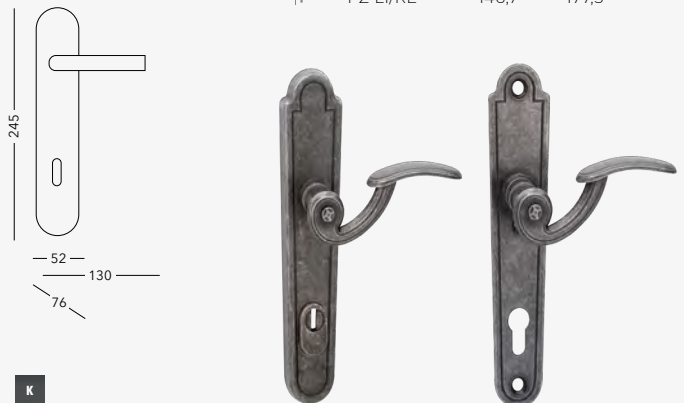

K

## Imst-R

<b>CZK</b>		bez DPH	s DPH
☞	BB/PZ	1140,0	1379,4
☞	PZ-LI/RE	1925,0	2329,3
<b>EUR</b>		bez DPH	s DPH
☞	BB/PZ	44,7	54,1
☞	PZ-LI/RE	75,5	91,3

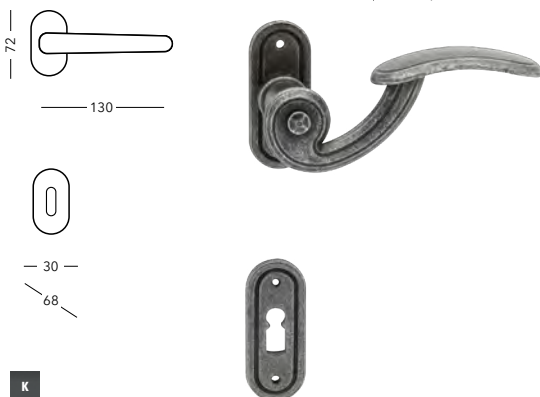

K

## Innsbruck

<b>CZK</b>		bez DPH	s DPH
☞	BB/PZ	3270,0	3956,7
☞	WC	4225,0	5112,3
☞	PZ-LI/RE	3675,0	4446,7
<b>EUR</b>		bez DPH	s DPH
☞	BB/PZ	127,3	154,0
☞	WC	165,6	200,4
☞	PZ-LI/RE	144,1	174,3

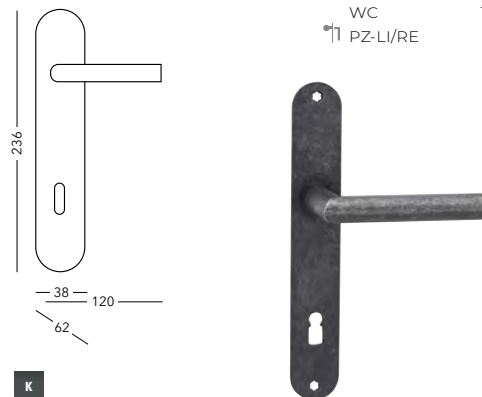

K

## Innsbruck-R

CZK		bez DPH	s DPH
🔑	BB/PZ	3245,0	3926,5
	WC	4225,0	5112,3
EUR		bez DPH	s DPH
🔑	BB/PZ	127,3	154,0
	WC	165,7	200,5

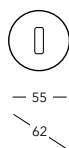
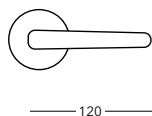

K

## Regen

CZK		bez DPH	s DPH
🔑	PZ L/R	3615,0	4374,2
	K PZ-LI/RE	3865,0	4676,7
🔑	K PZ-LI/RE	3865,0	4676,7
vyosená koule			
EUR		bez DPH	s DPH
🔑	PZ L/R	141,8	171,5
	K PZ-LI/RE	151,6	183,4
🔑	K PZ-LI/RE	151,6	183,4
vyosená koule			

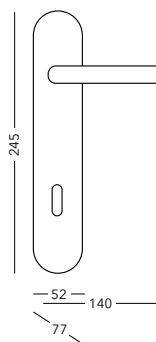

K



## Salzburg

CZK		bez DPH	s DPH
🔑	BB/PZ	3245,0	3926,5
	WC	4290,0	5190,9
🔑	PZ-LI/RE	3650,0	4416,5
EUR		bez DPH	s DPH
🔑	BB/PZ	127,3	154,0
	WC	168,2	203,6
🔑	PZ-LI/RE	143,1	173,2

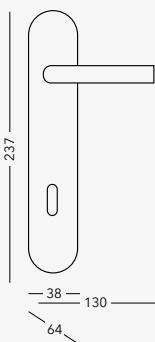

K



## Salzburg-S

CZK		bez DPH	s DPH
🔑	BB/PZ	3220,0	3896,2
	WC	4305,0	5209,1
EUR		bez DPH	s DPH
🔑	BB/PZ	126,3	152,8
	WC	168,8	204,3

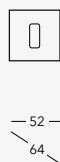
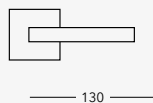

K

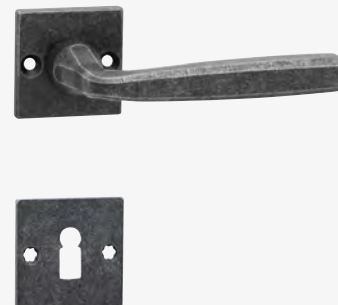

## Venezia

rustikální

CZK		bez DPH	s DPH
🔑	BB/PZ	615,0	744,2
	WC	745,0	901,5
🔑	PZ-LI/RE	810,0	980,1
EUR		bez DPH	s DPH
🔑	BB/PZ	24,1	29,2
	WC	29,2	35,4
🔑	PZ-LI/RE	31,8	38,4

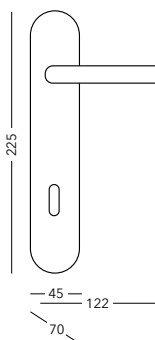

K

OFS



## Venezia-R

rustikální

CZK		bez DPH	s DPH
🔑	BB/PZ	680,0	822,8
	WC	810,0	980,1
🔑	PZ-LI/RE	870,0	1052,7
EUR		bez DPH	s DPH
🔑	BB/PZ	26,7	32,3
	WC	31,8	38,4
🔑	PZ-LI/RE	34,1	41,3

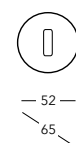
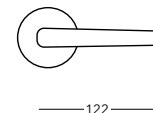

K





## Vienna-R+



<b>CZK</b>	bez DPH	s DPH
🔑 PZ-LI/RE	4980,0	6025,8
<b>EUR</b>	bez DPH	s DPH
🔑 PZ-LI/RE	195,3	236,3

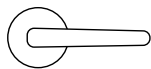

— 120 —



— 55 —

59



K

## Koule pevná Bonn HR

<b>CZK</b>	bez DPH	s DPH
cena ks	1235,0	1494,4
<b>EUR</b>	bez DPH	s DPH
cena ks	48,4	58,6



— 52 —

48



K

## Koule pevná Linz

<b>CZK</b>	bez DPH	s DPH
cena ks	1130,0	1367,3
<b>EUR</b>	bez DPH	s DPH
cena ks	44,3	53,6

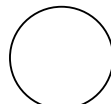

— Ø 55 —

45

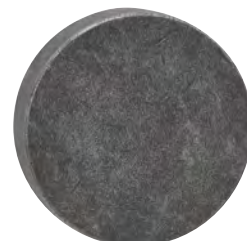

K

### SNADNÁ DOSTUPNOST

Produkty značky COBRA jsou snadno a rychle dostupné díky pečlivě budované husté síti obchodních partnerů. Podporujeme také on-line prodej, ale jsme si vědomi, že u kliky je důležitá možnost sáhnout si na ni, nebo na vlastní oči posoudit zvolený materiál. Proto nám záleží na tom, aby COBRA byla dostupná všem zákazníkům, kdykoliv a kdekoli.

### RYCHLÉ DODÁNÍ

Standardně dodáváme v nejrychlejších lhůtách. Máte jistotu, že vaše plány proběhnou tak, jak si představujete. Díky naší široké distribuční síti a stále dostupnosti našich výrobků můžeme slíbit, že se kliky COBRA dostanou vždy rychle a spolehlivě až k Vám.

[www.matekliku.cz](http://www.matekliku.cz)

### EASILY AVAILABLE

Cobra products are quickly and easily available owing to well-made network of business partners. We also support sales on – line despite the fact that we know it is very important having the possibility to touch the handle material and judge it with one`s own eyes . Therefore our main target is for COBRA to be available to all customers - anytime and anywhere.

### FAST DELIVERY

We usually deliver as fast as we can. You can be sure that your plans will take place according to your requirements. Thanks to our distribution network and availability of our products we are able to assure you that COBRA handles will easily and quickly find their way to you.

[www.matekliku.cz](http://www.matekliku.cz)

K





# Bezpečnostní a ochranné kování

## SECURITY FITTINGS

100	Alt-wien	102	Sveva	104	Přídavná rozeta kulatá
100	Alt-wien+	102	Sveva+	104	Přídavná rozeta oválná
100	C101+	102	Titan		
100	C201	102	Titan+		
100	C301	102	Tower		
101	C501+	103	Tower+		
101	Elegant	103	Tower-H		
101	Elegant+	104	Tower-H+		
101	Mars-S+	104	Rozeta Tower		
101	Slim-2	104	Přídavná rozeta hranatá		

**Prvořadým úkolem bezpečnostních kování je ochránit váš dům či byt. U nás máte možnost vybrat kliku nejen podle potřebné bezpečnostní třídy, ale zvolit si i svůj oblíbený design a povrch tak, aby i bezpečnostní kování odpovídalo vašim představám i celkovému designu vašeho obydlí.**

The main purpose of security fittings is to protect your house or flat. In our company you have a possibility to select a handle not only according to required security class, but you can also choose your favourite design and surface and security fitting in a way which would correspond with your wishes and the overall design of your dwelling.



## Alt-wien



Možno v rozteči 72, 90, 92

<b>CZK</b>	bez DPH	s DPH
🔑 PZ L/R	2365,0	2861,7
🔑 K PZ-LI/RE	2365,0	2861,7
<b>EUR</b>	bez DPH	s DPH
🔑 PZ L/R	92,7	112,2
🔑 K PZ-LI/RE	92,7	112,2

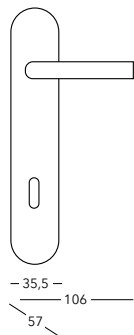

OFS OLV OV



## Alt-wien+



Možno v rozteči 72, 90, 92

<b>CZK</b>	bez DPH	s DPH
🔑 PZ L/R	2975,0	3599,8
🔑 K PZ-LI/RE	2975,0	3599,8
<b>EUR</b>	bez DPH	s DPH
🔑 PZ L/R	116,7	141,2
🔑 K PZ-LI/RE	116,7	141,2

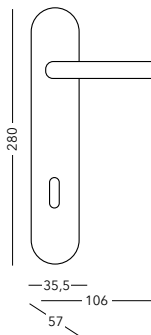

OFS OLV OV



## C101+



Možno v rozteči 72 a 90

<b>CZK</b>	bez DPH	s DPH
🔑 M PZ-LI/RE	765,0	925,7
🔑 PZ L/R	765,0	925,7
<b>EUR</b>	bez DPH	s DPH
🔑 M PZ-LI/RE	30,0	36,3
🔑 PZ L/R	30,0	36,3

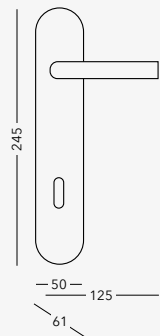

OFS ONS



## C201



Možno v rozteči 72 a 90

<b>CZK</b>	bez DPH	s DPH
🔑 PZ-LI/RE	880,0	1064,8
<b>EUR</b>	bez DPH	s DPH
🔑 PZ-LI/RE	34,5	41,8

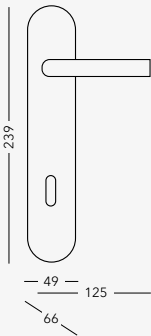

ONS OFS



## C301



Možno v rozteči 72 a 90

<b>CZK</b>	bez DPH	s DPH
🔑 PZ-LI/RE	880,0	1064,8
<b>EUR</b>	bez DPH	s DPH
🔑 PZ-LI/RE	34,5	41,8

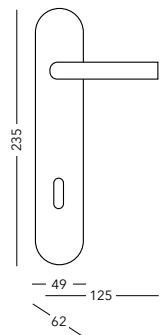

ONS OFS



## C501+



Možno v rozteči 72 a 90

<b>CZK</b>	bez DPH	s DPH
🔑 PZ L/R	2135,0	2583,4
🔑 K PZ-LI/RE	2135,0	2583,4
<b>EUR</b>	bez DPH	s DPH
🔑 PZ L/R	83,7	101,3
🔑 K PZ-LI/RE	83,7	101,3

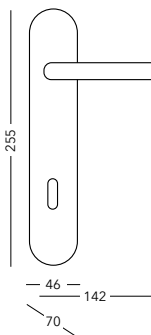

IN



## Elegant



Možno v rozteči 72, 90, 92

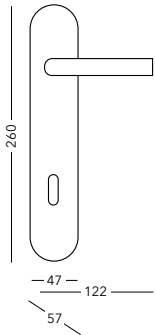

OFS OLV OV



CZK		bez DPH	s DPH
🔑	PZ L/R	1965,0	2377,7
🔑	K PZ-LI/RE	1965,0	2377,7
EUR		bez DPH	s DPH
🔑	PZ L/R	77,1	93,2
🔑	PZ-LI/RE	77,1	93,2

## Elegant+



Možno v rozteči 72, 90, 92

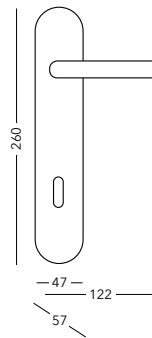

OFS OLV OV



CZK		bez DPH	s DPH
🔑	PZ L/R	2795,0	3382,0
🔑	K PZ-LI/RE	2795,0	3382,0
EUR		bez DPH	s DPH
🔑	PZ L/R	109,6	132,6
🔑	PZ-LI/RE	109,6	132,6

## Mars-S+



3

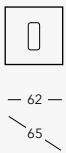
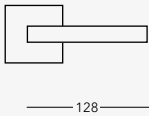

F1



CZK		bez DPH	s DPH
🔑	PZ L/R	2620,0	3170,2
🔑	K PZ-LI/RE	2840,0	3436,4
EUR		bez DPH	s DPH
🔑	PZ L/R	107,1	129,5
🔑	K PZ-LI/RE	115,7	140,0

CZK		bez DPH	s DPH	EUR		bez DPH	s DPH
🔑	PZ L/R	2730,0	3303,3	🔑	PZ L/R	107,1	129,5
🔑	K PZ-LI/RE	2950,0	3569,5	🔑	K PZ-LI/RE	115,7	140,0

Cerná

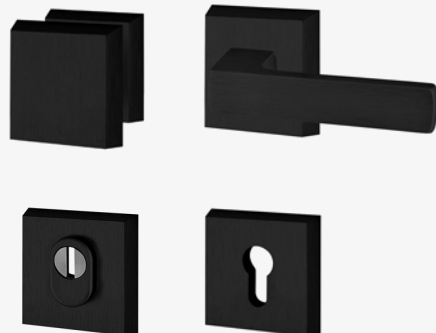

## Slim-2



Možno v rozteči 72, 90, 92

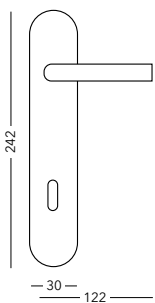

F1 F4



CZK		bez DPH	s DPH
🔑	PZ L/R	620,0	750,2
🔑	K PZ-LI/RE	670,0	810,7
EUR		bez DPH	s DPH
🔑	PZ L/R	24,3	29,4
🔑	PZ-LI/RE	26,3	31,8

## Slim-2



Možno v rozteči 72, 90, 92

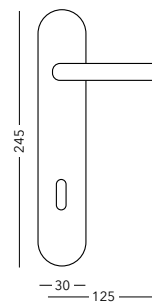

F9



CZK		bez DPH	s DPH
🔑	PZ L/R	670,0	810,7
	PZ-LI/RE	710,0	859,1
EUR		bez DPH	s DPH
🔑	PZ L/R	26,3	31,8
	PZ-LI/RE	27,8	33,7

## Sveva



Možno v rozteči 72, 90, 92

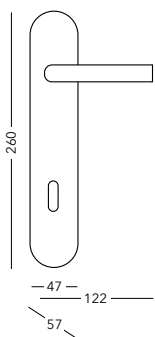

OC ONS OFS OLV

CZK	bez DPH	s DPH
☰ PZ L/R	1515,0	1833,2
☰ K PZ-LI/RE	1515,0	1833,2

EUR	bez DPH	s DPH
☰ PZ L/R	59,4	71,9
☰ PZ-LI/RE	59,4	71,9



## Sveva+



Možno v rozteči 72, 90, 92

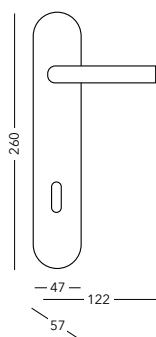

OC ONS OFS OLV

CZK	bez DPH	s DPH
☰ PZ L/R	2395,0	2898,0
☰ K PZ-LI/RE	2395,0	2898,0

EUR	bez DPH	s DPH
☰ PZ L/R	93,9	113,6
☰ PZ-LI/RE	93,9	113,6



## Titan



Možno v rozteči 72, 90, 92

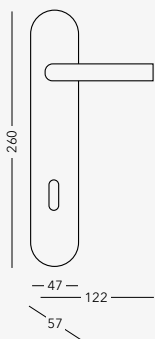

OC ONS OFS OLV

CZK	bez DPH	s DPH
☰ Z L/R	1515,0	1833,2
☰ K PZ-LI/RE	1515,0	1833,2

EUR	bez DPH	s DPH
☰ PZ L/R	59,4	71,9
☰ PZ-LI/RE	59,4	71,9



## Titan+



Možno v rozteči 72, 90, 92

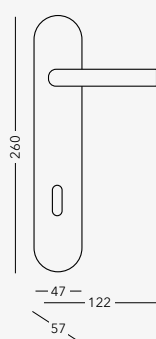

OC ONS OFS OLV

CZK	bez DPH	s DPH
☰ PZ L/R	2395,0	2898,0
☰ K PZ-LI/RE	2395,0	2898,0

EUR	bez DPH	s DPH
☰ PZ L/R	93,9	113,6
☰ PZ-LI/RE	93,9	113,6



## Tower



Možno v rozteči 72, 90, 92

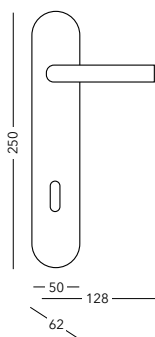

F1 F4

CZK	bez DPH	s DPH
☰ PZ L/R	1000,0	1210,0
☰ K PZ-LI/RE	1000,0	1210,0

EUR	bez DPH	s DPH
☰ PZ L/R	39,2	47,5
☰ PZ-LI/RE	39,2	47,5



## Tower



Možno v rozteči 72, 90, 92

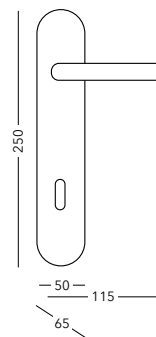

F9

CZK	bez DPH	s DPH
☰ PZ L/R	1100,0	1331,0
☰ K PZ-LI/RE	1100,0	1331,0

EUR	bez DPH	s DPH
☰ PZ L/R	43,5	52,2
☰ PZ-LI/RE	43,5	52,2



# Tower+



Možno v rozteči 72, 90, 92

<b>CZK</b>	bez DPH	s DPH
🔑 PZ L/R	1800,0	2178,0
🔑 K PZ-LI/RE	1800,0	2178,0

<b>EUR</b>	bez DPH	s DPH
🔑 PZ L/R	69,5	83,4
🔑 PZ-LI/RE	69,5	83,4

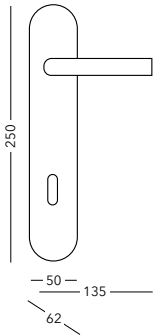

Cerná



# Tower+



Možno v rozteči 72, 90, 92

<b>CZK</b>	bez DPH	s DPH
🔑 PZ L/R	1390,0	1681,9
🔑 K PZ-LI/RE	1390,0	1681,9

<b>EUR</b>	bez DPH	s DPH
🔑 PZ L/R	54,5	66,0
🔑 PZ-LI/RE	54,5	66,0

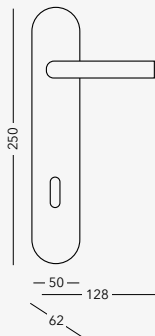

F1 F4

# Tower+



Možno v rozteči 72, 90, 92

<b>CZK</b>	bez DPH	s DPH
🔑 PZ L/R	1490,0	1802,9
🔑 K PZ-LI/RE	1490,0	1802,9

<b>EUR</b>	bez DPH	s DPH
🔑 PZ L/R	58,4	70,7
🔑 PZ-LI/RE	58,4	70,7

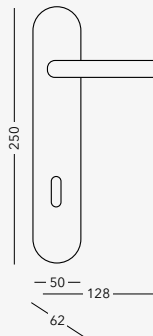

F9

# Tower-H



Možno v rozteči 72, 90, 92

<b>CZK</b>	bez DPH	s DPH
🔑 PZ L/R	1050,0	1270,5
🔑 K PZ-LI/RE	1050,0	1270,5

<b>EUR</b>	bez DPH	s DPH
🔑 L/R	41,2	49,8
🔑 PZ-LI/RE	41,2	49,8

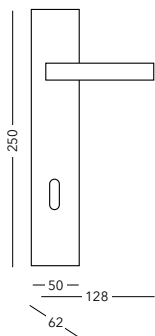

F1 F4

# Tower-H



Možno v rozteči 72, 90, 92

<b>CZK</b>	bez DPH	s DPH
🔑 PZ L/R	1150,0	1391,5
🔑 K PZ-LI/RE	1150,0	1391,5

<b>EUR</b>	bez DPH	s DPH
🔑 PZ L/R	45,1	54,6
🔑 PZ-LI/RE	45,1	54,6

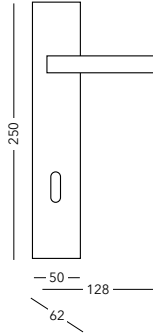

F9



## Tower-H+



Možno v rozteči 72, 90, 92

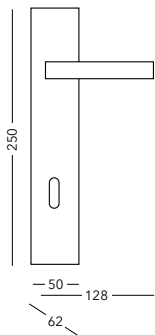

F1 F4



CZK		bez DPH	s DPH
🔑	PZ L/R	1440,0	1742,4
🔑	K PZ-LI/RE	1440,0	1742,4

EUR		bez DPH	s DPH
🔑	PZ L/R	56,5	68,3
🔑	PZ-LI/RE	56,5	68,3



Možno v rozteči 72, 90, 92

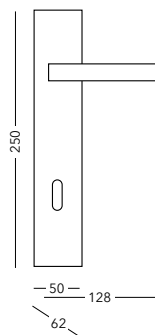

F9



CZK		bez DPH	s DPH
🔑	PZ L/R	1550,0	1875,5
🔑	K PZ-LI/RE	1550,0	1875,5

EUR		bez DPH	s DPH
🔑	PZ L/R	60,8	73,5
🔑	PZ-LI/RE	60,8	73,5

## Rozeta Tower

🔒 cena za pár

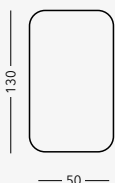

CZK		bez DPH	s DPH
🔑	PZ	840,0	1016,4

EUR		bez DPH	s DPH
🔑	PZ	32,9	39,9

## Přídavná rozeta hranatá

🔒 cena za pár

Povrch	obj.číslo	CZK	s DPH	EUR	s DPH
IN	ALMBROZHE 349	🔑 PZ 1590,0	1923,9	62,4	75,4
OLV	ALMBROZHE 379	🔑 PZ 1590,0	1923,9	62,4	75,4

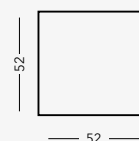

F1 F9 F4

## Přídavná rozeta kulatá

🔒 cena za pár

Povrch	obj.číslo	CZK	s DPH	EUR	s DPH
IN	ALMBROZKE 369	🔑 PZ 1415,0	1712,2	55,5	67,1
OLV	ALMBROZKE 399	🔑 PZ 1415,0	1712,2	55,5	67,1

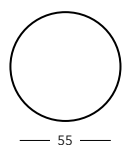

## Přídavná rozeta oválná

🔒 cena za pár

Povrch	obj.číslo	CZK	s DPH	EUR	s DPH
IN	ALMBROZOE 359	🔑 PZ 1195,0	1446,0	46,9	56,7
OLV	ALMBROZOE 389	🔑 PZ 1195,0	1446,0	46,9	56,7

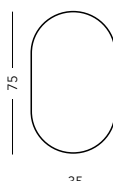

BK



# S

## Sety

### SETS

#### Set Alt-wien

- 108 Alt-wien
- 108 Alt-wien ochranné
- 108 Okenní kování
- 108 Oliva
- 108 Půloliva
- 108 Půloliva velká
- 108 Úchytka 3665 bez otvoru
- 108 Úchytka 3665 BB
- 108 Úchytka 3665 WC

#### Set Vision

- 109 Vision-R III
- 109 R-701+
- 109 Oliva Vision
- 109 Půloliva Vision
- 109 Balkónová klika Vision
- 109 Úchytka hranatá bez otvoru
- 109 Úchyt 3665 narážecí
- 109 Úchyt na posuvné dveře D

#### Set hliník

- 110 Universal
- 110 Tower-H
- 110 Universal-R
- 110 Tower
- 110 Oliva
- 110 Balkónová klika ST3



**Chcete sladit design dveřních a okenních kování s okny? Připravili jsme pro vás kompletní sety, které vám umožní vybavit dveře i okna kováními a úchyty v totožném povrchu i tvaru a dosáhnout tak celkového sjednocení zásadních designových prvků vaší domácnosti.**

Do you wish to match the design of your doors and windows fittings? We have prepared complete sets which will enable you to fit the doors as well as windows with fittings and mountings in an identical surface and shape thus reaching the overall integration of essential design elements of your household.



# Set Alt-wien

## Alt-wien

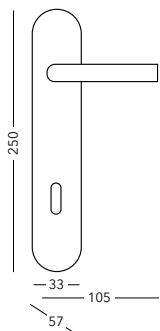

CZK		bez DPH	s DPH
🔑	BB/PZ	725,0	877,3
	WC	895,0	1083,0
🔑	PZ-LI/RE	980,0	1185,8
EUR		bez DPH	s DPH
🔑	BB/PZ	28,4	34,4
	WC	35,1	42,5
🔑	PZ-LI/RE	38,4	46,5

## Alt-wien

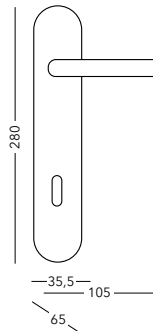

CZK		bez DPH	s DPH
🔑	PZ L/R	2365,0	2861,7
🔑	K PZ-LI/RE	2365,0	2861,7
EUR		bez DPH	s DPH
🔑	PZ L/R	92,7	112,2
🔑	K PZ-LI/RE	92,7	112,2

## Okenní kování Alt-Wien



Oliva  
obj. číslo

P06458X60B

CZK	bez DPH	s DPH
cena	370,0	447,7
EUR	bez DPH	s DPH
PZ L/R	14,5	17,6

Půlolina  
obj. číslo

P06448X00B

CZK	bez DPH	s DPH
cena	350,0	423,5
EUR	bez DPH	s DPH
PZ L/R	13,7	16,6

Půlolina velká  
obj. číslo

P06468X00N

CZK	bez DPH	s DPH
cena	390,0	471,9
EUR	bez DPH	s DPH
PZ L/R	14,5	17,4

Balkonová klika  
obj. číslo

P06478X00B

CZK	bez DPH	s DPH
cena	485,0	586,9
EUR	bez DPH	s DPH
PZ L/R	18,0	21,6

Rozvora  
obj. číslo

P06438X00B

CZK	bez DPH	s DPH
cena	465,0	562,7
EUR	bez DPH	s DPH
PZ L/R	18,2	22,1

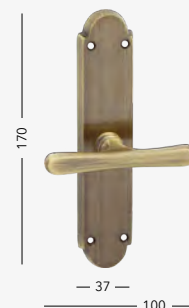
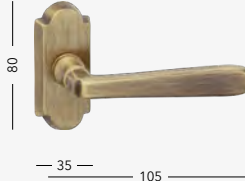
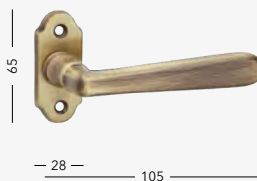
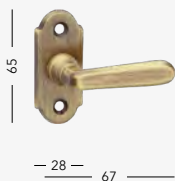
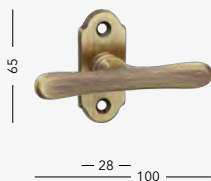

## Úchytky 3665



bez otvoru

obj. číslo P17908PRX03PAR

CZK	bez DPH	s DPH
cena za pár	660,0	798,6
EUR	bez DPH	s DPH
cena za pár	25,9	31,3

BB

obj. číslo P17908X13PAR

CZK	bez DPH	s DPH
cena za pár	475,0	574,8
EUR	bez DPH	s DPH
cena za pár	18,6	22,5

WC

obj. číslo P17908X3312PAR

CZK	bez DPH	s DPH
cena za pár	760,0	919,6
EUR	bez DPH	s DPH
cena za pár	29,8	36,1



# Set Vision

## Vision-R III

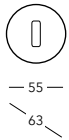
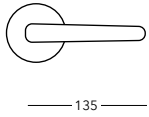

IN

	CZK	bez DPH	s DPH
BB/PZ	300,0	300,0	363,0
WC	485,0	485,0	586,9
PZ-LI/RE	550,0	550,0	665,5

	EUR	bez DPH	s DPH
BB/PZ	11,8	11,8	14,2
WC	19,0	19,0	23,0
PZ-LI/RE	21,6	21,6	26,1



## C501+



Možno v rozteči 72 a 90

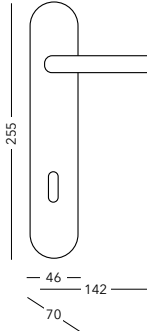

IN

	CZK	bez DPH	s DPH
PZ L/R	2135,0	2135,0	2583,4
PZ-LI/RE	2135,0	2135,0	2583,4

	EUR	bez DPH	s DPH
PZ L/R	83,7	83,7	101,3
PZ-LI/RE	83,7	83,7	101,3



## Okenní kování Vision

IN

### Oliva Vison

	CZK	bez DPH	s DPH
cena	335,0	335,0	405,4
	EUR	bez DPH	s DPH
PZ L/R	13,1	13,1	15,9

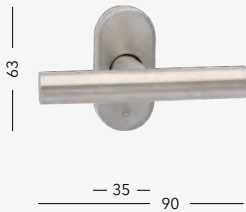

### Půlolina Vison

	CZK	bez DPH	s DPH
cena	300,0	300,0	363,0
	EUR	bez DPH	s DPH
PZ L/R	11,8	11,8	14,2

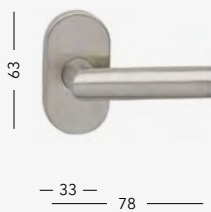

### Balk. Vison

	CZK	bez DPH	s DPH
cena	325,0	325,0	393,3
	EUR	bez DPH	s DPH
PZ L/R	12,7	12,7	15,4

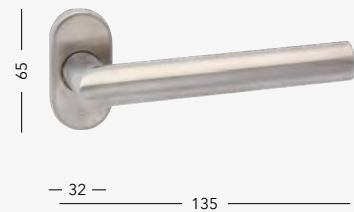

## Úchytky Nerezové

IN

### Hranatá bez otvoru

obj. číslo	C1592EX03		
	CZK	bez DPH	s DPH
cena za kus	235,0	235,0	284,4
	EUR	bez DPH	s DPH
cena za kus	9,2	9,2	11,2

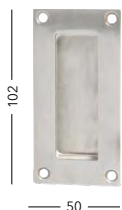

### Úchyt 3665 narážecí

obj. číslo	P1790EX03PAR		
	CZK	bez DPH	s DPH
cena za pár	460,0	460,0	556,6
	EUR	bez DPH	s DPH
cena za pár	18,0	18,0	21,8



### Úchyt pos. dveře D

obj. číslo	C160EXD		
	CZK	bez DPH	s DPH
cena za kus	375,0	375,0	453,8
	EUR	bez DPH	s DPH
cena za kus	14,7	14,7	17,8

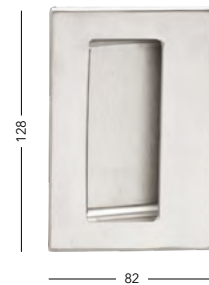

# Set Hliník

## Universal

OK 100 tis.

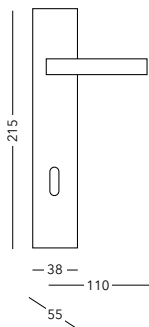

F1 F4



	bez DPH	s DPH
<b>CZK</b>		
BB/PZ	245,0	296,5
WC	310,0	375,1
PZ-LI/RE	375,0	453,8

	bez DPH	s DPH
<b>EUR</b>		
BB/PZ	9,6	11,6
WC	12,2	14,7
PZ-LI/RE	14,7	17,8

## Tower H

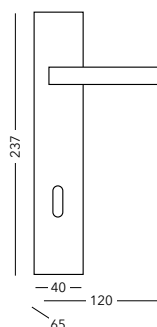

F1 F4



	bez DPH	s DPH
<b>CZK</b>		
BB/PZ	1050,0	1270,5
PZ-LI/RE	1050,0	1270,5

	bez DPH	s DPH
<b>EUR</b>		
BB/PZ	41,2	49,8
PZ-LI/RE	41,2	49,8

## Universal-R

OK 100 tis.

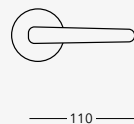

F1 F4



	bez DPH	s DPH
<b>CZK</b>		
BB/PZ	245,0	296,5
WC	310,0	375,1
PZ-LI/RE	375,0	453,8

	bez DPH	s DPH
<b>EUR</b>		
BB/PZ	9,6	11,6
WC	12,2	14,7
PZ-LI/RE	14,7	17,8

## Tower

OK

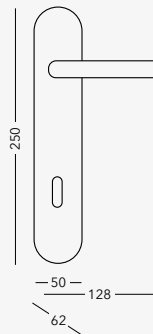

F1 F4



	bez DPH	s DPH
<b>CZK</b>		
PZ L/R	1000,0	1210,0
K PZ-LI/RE	1000,0	1210,0

	bez DPH	s DPH
<b>EUR</b>		
PZ L/R	39,2	47,5
PZ-LI/RE	39,2	47,5

## Okenní kování

F1 F4

Oliva

	bez DPH	s DPH
<b>CZK</b>		
cena	120,0	145,2
<b>EUR</b>		
PZ L/R	4,7	5,7

Půlolliva

	bez DPH	s DPH
<b>CZK</b>		
cena	130,0	157,3
<b>EUR</b>		
PZ L/R	5,1	6,2

Balkonová klika ST3

	bez DPH	s DPH
<b>CZK</b>		
cena	200,0	242,0
<b>EUR</b>		
PZ L/R	7,8	9,5

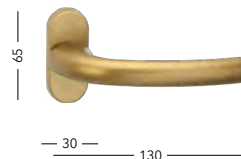
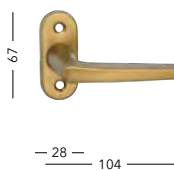
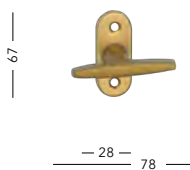





# F1

## Stříbrný elox

SILVER ELOX

- 114 Monet
- 114 Monet-R
- 114 Universal
- 114 Universal-R



Jednou z významných předností našich nabízených klik ze stříbrného eloxu je jejich odolný povrch. Díky povrchové úpravě jsou odolnější vůči poškrábání a snesou tvrdší zacházení. Barevný odstín stříbrného eloxu předurčuje kliky do světlých interiérů.

One of the advantages of our handles made of silver elox is their durable surface. Thanks to its finishing, elox is more durable against scratching and they can also endure harsher treatment. Coloured shade of silver elox makes the handles a great choice especially in light interiors.



## Monet

100 tis.

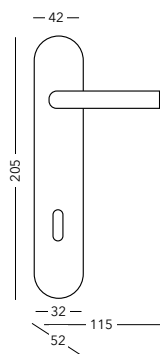

CZK		bez DPH	s DPH
🔑	BB/PZ	245,0	296,5
	WC	320,0	387,2
🔑	PZ-LI/RE	375,0	453,8
EUR		bez DPH	s DPH
🔑	BB/PZ	9,6	11,6
	WC	12,5	15,2
🔑	PZ-LI/RE	14,7	17,8



F1 F4

## Monet-R

100 tis. PR



112

50  
52

CZK		bez DPH	s DPH
🔑	BB/PZ	245,0	296,5
	WC	320,0	387,2
EUR		bez DPH	s DPH
🔑	BB/PZ	9,6	11,6
	WC	12,5	15,2



F1 F4

## Universal

100 tis.

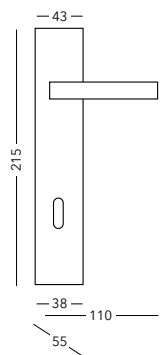

CZK		bez DPH	s DPH
🔑	BB/PZ	245,0	296,5
	WC	320,0	387,2
🔑	PZ-LI/RE	375,0	453,8
EUR		bez DPH	s DPH
🔑	BB/PZ	9,6	11,6
	WC	12,5	15,2
🔑	PZ-LI/RE	14,7	17,8



F1 F4

## Universal-R

100 tis. PR

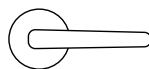

110

50  
55

CZK		bez DPH	s DPH
🔑	BB/PZ	245,0	296,5
	WC	310,0	375,1
🔑	PZ-LI/RE	375,0	453,8
EUR		bez DPH	s DPH
🔑	BB/PZ	9,6	11,6
	WC	12,2	14,7
🔑	PZ-LI/RE	14,7	17,8



F1 F4

### SNADNÁ DOSTUPNOST

produkty COBRA jsou snadno a rychle dostupné díky pečlivě budované síti obchodních partnerů. Podporujeme také on-line prodej, ale víme, že u kliky je důležitá možnost sáhnout si na ni a na vlastní oči posoudit zvolný materiál. Proto nám záleží na tom, aby COBRA byla dostupná všem zákazníkům - kdykoliv a kdekoliv.

### RYCHLÉ DODÁNÍ

Standardně dodáváme v nejrychlejších lhůtách. Máte jistotu, že vaše plány proběhnou tak, jak si představujete. Díky naší distribuční síti a dostupnosti našich výrobků můžeme slíbit, že se kliky COBRA dostanou vždy rychle a spolehlivě až k vám.



**COBRA**<sup>®</sup> 

#### **EASILY AVAILABLE**

Cobra products are quickly and easily available owing to well-made network of business partners. We also support sales on – line despite the fact that we know it is very important having the possibility to touch the handle material and judge it with one`s own eyes . Therefore our main target is for COBRA to be available to all customers - anytime and anywhere.

#### **FAST DELIVERY**

We usually deliver as fast as we can. You can be sure that your plans will take place according to your requirements. Thanks to our distribution network and availability of our products we are able to assure you that COBRA handles will easily and quickly find their way to you.

# F4

## Bronzový elox

BRASS ELOX

118 Monet  
118 Monet-R  
118 Universal  
118 Universal-R



**Významnou předností kování z bronzového eloxu je jejich odolný povrch. Povrchová úprava zajišťuje větší tvrdost a odolnost vůči poškrábání.**

Significant advantage of brass elox fittings is their resistant surface. Elox finishing allows higher durability against scratching.



## Monet

100 tis.

	CZK	bez DPH	s DPH
🔑	BB/PZ	245,0	296,5
	WC	310,0	375,1
🔑	PZ-LI/RE	375,0	453,8
<b>EUR</b>			
🔑	BB/PZ	9,6	11,6
	WC	12,2	14,7
🔑	PZ-LI/RE	14,7	17,8

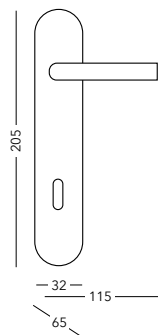

F1 F4

## Monet-R

100 tis. PR

	CZK	bez DPH	s DPH
🔑	BB/PZ	245,0	296,5
	WC	310,0	375,1
<b>EUR</b>			
🔑	BB/PZ	9,6	11,6
	WC	12,2	14,7

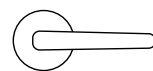

F1 F4

## Universal

100 tis.

	CZK	bez DPH	s DPH
🔑	BB/PZ	245,0	296,5
	WC	310,0	375,1
🔑	PZ-LI/RE	375,0	453,8
<b>EUR</b>			
🔑	BB/PZ	9,6	11,6
	WC	12,2	14,7
🔑	PZ-LI/RE	14,7	17,8

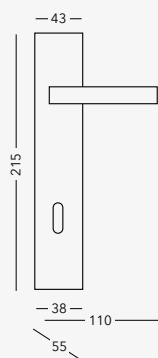

F1 F4

## Universal-R

100 tis. PR

	CZK	bez DPH	s DPH
🔑	BB/PZ	245,0	296,5
	WC	310,0	375,1
🔑	PZ-LI/RE	375,0	453,8
<b>EUR</b>			
🔑	BB/PZ	9,6	11,6
	WC	12,2	14,7
🔑	PZ-LI/RE	14,7	17,8

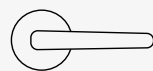

F1 F4

### ODBORNÉ PORADENSTVÍ ZDARMA

Vybírejte bez starostí. S čímkoliv bude třeba, rádi poradíme. Pravidelným školením a vzděláváním naší obchodní sítě zajišťujeme, aby vám odborníci vždy dokázali správně poradit nebo doporučit nejvhodnější kliku.

### POPRODEJNÍ SERVIS

COBRA ručí za spolehlivé fungování. Prodejem naše péče o zákazníky nekončí. Pečlivě a systematicky rozvíjíme a podporujeme síť našich partnerů, kteří jsou díky tomu vždy připraveni poskytnout vám poprodejný servis spojený s údržbou našich výrobků nebo s dodávkou náhradních dílů.

### FREE OF CHARGE CONSULTANCY

Be worry-free while you choose. Whatever the issue, we will be glad to help you. Thanks to regular training programmes and continuous education of our commercial network we can ensure that our professionals are always able to assist you or to recommend you the most appropriate handle..

### AFTER SALES SERVICE

COBRA guarantees reliable functioning. Selling our product does not mean the end of our customer care. We carefully and systematically develop and support network of our business partners who are thus ready to provide you with after sales services related to our products` maintenance as well as with the delivery of spare parts.





# OKENNÍ KOVÁNÍ

## Okenní kování

WINDOW FITTINGS

122 Alt-wien  
123 Elegant

124 F1  
124 F4

125 kované  
125 Vision





# Okenní kování Alt-Wien

staromosaz

## Oliva

<b>CZK</b>	s DPH
400,0	484,0
<b>EUR</b>	s DPH
15,7	19,0

## Půloliva

<b>CZK</b>	s DPH
370,0	447,7
<b>EUR</b>	s DPH
14,5	17,6

## Půloliva velká

<b>CZK</b>	s DPH
410,0	496,1
<b>EUR</b>	s DPH
16,1	19,5

## Balkonová klika

<b>CZK</b>	s DPH
515,0	623,2
<b>EUR</b>	s DPH
20,2	24,4

## Rozvora

<b>CZK</b>	s DPH
485,0	586,9
<b>EUR</b>	s DPH
19,0	23,0

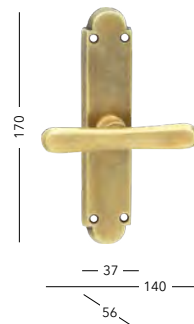
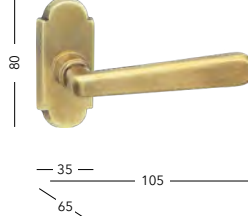
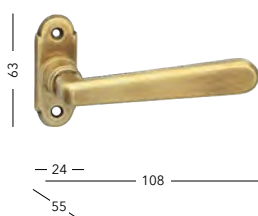
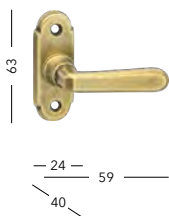
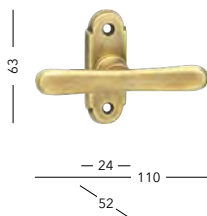

**ov** Za příplatek lze dodat i s metrickými šrouby M5x16.

# Okenní kování Alt-Wien

nikl matný, leštěná mosaz, česaný bronz, chrom, chrom matný

## Oliva

<b>CZK</b>	s DPH
370,-	447,7
<b>EUR</b>	s DPH
14,5	17,6

## Půloliva

<b>CZK</b>	s DPH
350,0	423,5
<b>EUR</b>	s DPH
13,6	16,3

## Půloliva velká

<b>CZK</b>	s DPH
390,0	471,9
<b>EUR</b>	s DPH
15,3	18,5

## Balkonová klika

<b>CZK</b>	s DPH
485,0	586,9
<b>EUR</b>	s DPH
19,0	2

## Rozvora

<b>CZK</b>	s DPH
465,0	562,7
<b>EUR</b>	s DPH
18,2	22,1

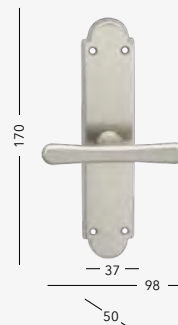
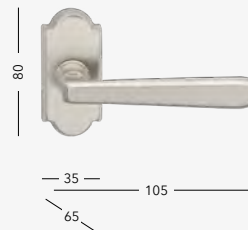
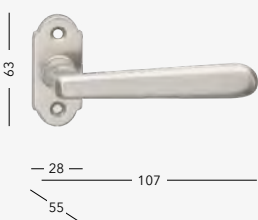
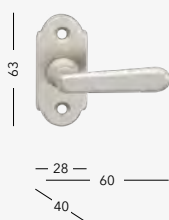
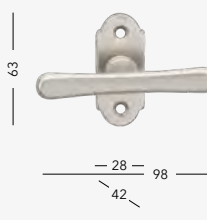

**ONS OFS OLV OC OCS** Za příplatek lze dodat i s metrickými šrouby M5x16.

# Okenní kování Elegant

staromosaz

## Oliva

<b>CZK</b>	350,0	± DPH	423,5
<b>EUR</b>	13,7	± DPH	16,6

## Půloliva

<b>CZK</b>	330,0	± DPH	399,3
<b>EUR</b>	12,9	± DPH	15,7

## Půloliva velká

<b>CZK</b>	400,0	± DPH	484,0
<b>EUR</b>	15,7	± DPH	19,0

## Balkonová klika

<b>CZK</b>	455,0	± DPH	550,6
<b>EUR</b>	17,8	± DPH	21,6

## Rozvora

<b>CZK</b>	420,0	± DPH	508,2
<b>EUR</b>	16,5	± DPH	19,9

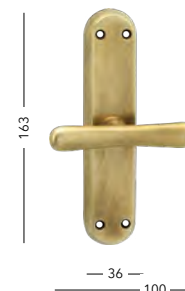
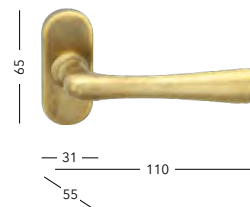
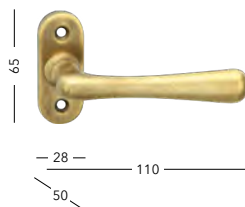
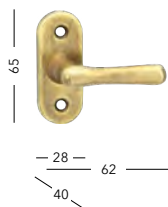
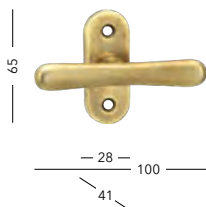

**ov** Za příplatek lze dodat i s metrickými šrouby M5x16.

# Okenní kování Elegant

nikl matný, leštěná mosaz, česaný bronz

## Oliva

<b>CZK</b>	330,0	± DPH	399,3
<b>EUR</b>	12,9	± DPH	15,7

## Půloliva

<b>CZK</b>	295,0	± DPH	357,0
<b>EUR</b>	11,6	± DPH	14,0

## Půloliva velká

<b>CZK</b>	370,0	± DPH	447,7
<b>EUR</b>	14,5	± DPH	17,6

## Balkonová klika

<b>CZK</b>	370,0	± DPH	447,7
<b>EUR</b>	14,5	± DPH	17,6

## Rozvora

<b>CZK</b>	400,0	± DPH	484,0
<b>EUR</b>	15,7	± DPH	19,0

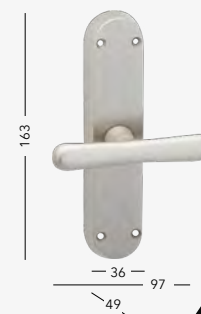
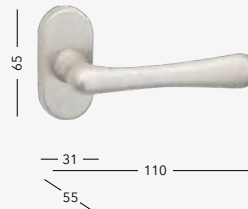
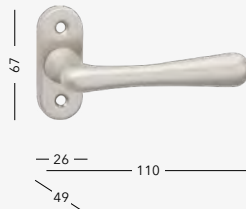
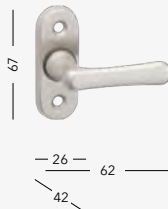
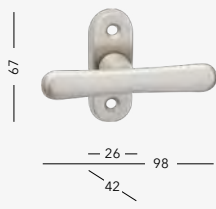

**ONS OFS OLV OC OCS** Za příplatek lze dodat i s metrickými šrouby M5x16.

# Okenní kování F1

stříbrný elox

## Oliva

<b>CZK</b>	s DPH
120,0	145,2
<b>EUR</b>	s DPH
4,7	5,7

## Půloliva

<b>CZK</b>	s DPH
130,0	157,3
<b>EUR</b>	s DPH
5,1	6,2

## Balkonová klika

<b>CZK</b>	s DPH
200,0	242,0
<b>EUR</b>	s DPH
7,8	9,5

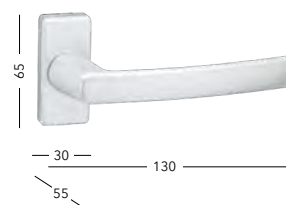
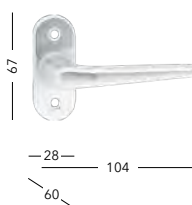
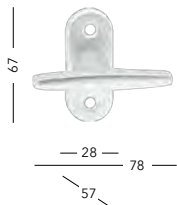

F1

# Okenní kování F4

bronzový elox

## Oliva

<b>CZK</b>	s DPH
120,0	145,2
<b>EUR</b>	s DPH
4,7	5,7

## Půloliva

<b>CZK</b>	s DPH
130,0	157,3
<b>EUR</b>	s DPH
5,1	6,2

## Balkonová klika

<b>CZK</b>	s DPH
200,0	242,0
<b>EUR</b>	s DPH
7,8	9,5

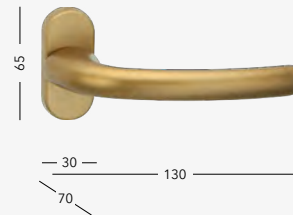
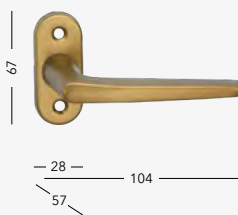
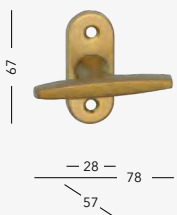

F4

# Okenní kování kované

## Oliva Hamburg

<b>CZK</b>	s DPH
1150,0	1391,5
<b>EUR</b>	s DPH
45,1	54,6

## Půlolina velká Hamburg

<b>CZK</b>	s DPH
1290,0	1560,9
<b>EUR</b>	s DPH
50,6	61,2

## Oliva Manheim

<b>CZK</b>	s DPH
1150,0	1391,5
<b>EUR</b>	s DPH
45,1	54,6

## Půlolina velká Manheim

<b>CZK</b>	s DPH
1290,0	1560,9
<b>EUR</b>	s DPH
50,6	61,2

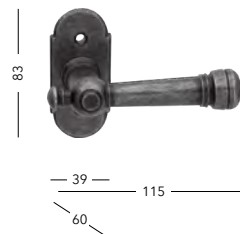
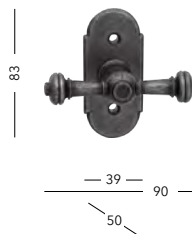
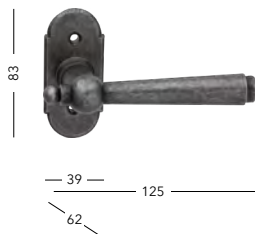
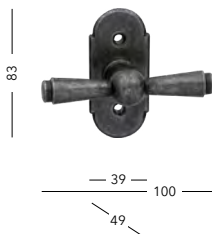

K

# Okenní kování Vision

nerez

## Oliva

<b>CZK</b>	s DPH
335,0	405,4
<b>EUR</b>	s DPH
13,1	15,9

## Půlolina

<b>CZK</b>	s DPH
300,0	363,0
<b>EUR</b>	s DPH
11,8	14,2

## Balkónová klika

<b>CZK</b>	s DPH
325,0	393,3
<b>EUR</b>	s DPH
12,7	15,4

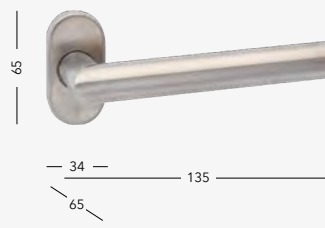
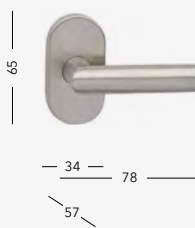
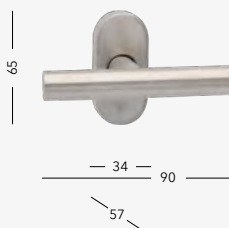

IN

# MADLA ÚCHYTY

## Madla / úchyty

PULL HANDLES / SLIDING DOOR PLATES

128	Madla Inox	133	Náprstky MQ	135	Úchytky
128	Madla	133	Náprstky MT	135	Úchytky kované 001
130	Madlo Bregenz	133	Úchyt 3663	135	Úchytky kované 003
130	Madlo Stein	133	Úchyt 3665	135	Úchytky kované 004
131	Madla na míru jednostranná	134	Úchyt 3666 Kulatá	135	Úchytky Ulmen
132	Madla na míru oboustranná	134	Úchyt 3667 Hranatá	135	Úchytky Nurnberg
132	Posuvný systém	134	Úchyty		

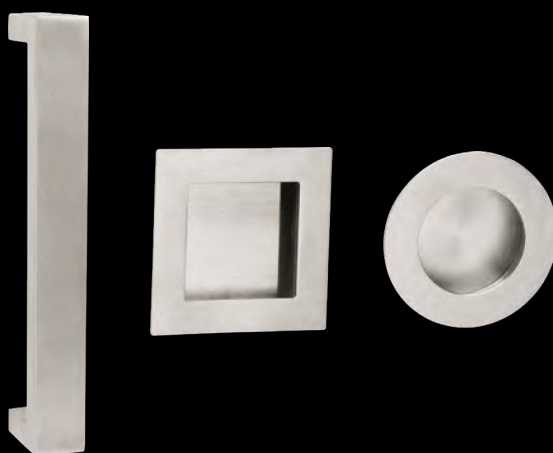





## Madla INOX

Povrch	typ provedení	obj. číslo kus	CZK	s DPH	EUR	s DPH	obj. číslo pár	CZK	s DPH	EUR	s DPH
IN	INOX A	CHMADLOA	905,0	1095,1	35,5	42,9	CHMADLOAP	1135,0	1373,4	44,5	53,9
IN	INOX B	CHMADLOB	990,0	1197,9	38,8	47,0	CHMADLOBP	1365,0	1651,7	53,5	64,8
IN	INOX C	CHMADLOC	875,0	1058,8	34,3	41,5	CHMADLOCP	1020,0	1234,2	40,0	48,4
IN	INOX D	CHMADLOD	1020,0	1234,2	40,0	48,4	CHMADLODP	1365,0	1651,7	53,5	64,8
IN	INOX E	CHMADLOE	1020,0	1234,2	40,0	48,4	CHMADLOEP	1135,0	1373,4	44,5	53,9
IN	INOX F	CHMADLOF	1020,0	1234,2	40,0	48,4	CHMADLOFP	1135,0	1373,4	44,5	53,9
IN	INOX G 350	CHMADLOG	845,0	1022,5	33,1	40,1	CHMADLOGP	1060,0	1282,6	41,6	50,3
IN	INOX G 500	CHMADLOH	950,0	1149,5	37,3	45,1	CHMADLOHP	1165,0	1409,7	45,7	55,3
IN	INOX G 600	CHMADLOG	905,0	1095,1	35,5	42,9	CHMADLOGP	1135,0	1373,4	44,5	53,9
IN	INOX G 700	CHMADLOH	1020,0	1234,2	40,0	48,4	CHMADLOHP	1250,0	1512,5	49,0	59,3
IN	INOX G 800	CHMADLOI	1135,0	1373,4	44,5	53,9	CHMADLOIP	1365,0	1651,7	53,5	64,8
IN	INOX G 900	CHMADLOK	1250,0	1512,5	49,0	59,3	CHMADLOKP	1485,0	1796,9	58,2	70,5
IN	INOX G 1000	CHMADLOJ	1365,0	1651,7	53,5	64,8	CHMADLOJP	1590,0	1923,9	62,4	75,4
IN	INOX G 1100	CHMADLOL	1365,0	1651,7	53,5	64,8	CHMADLOLP	1590,0	1923,9	62,4	75,4

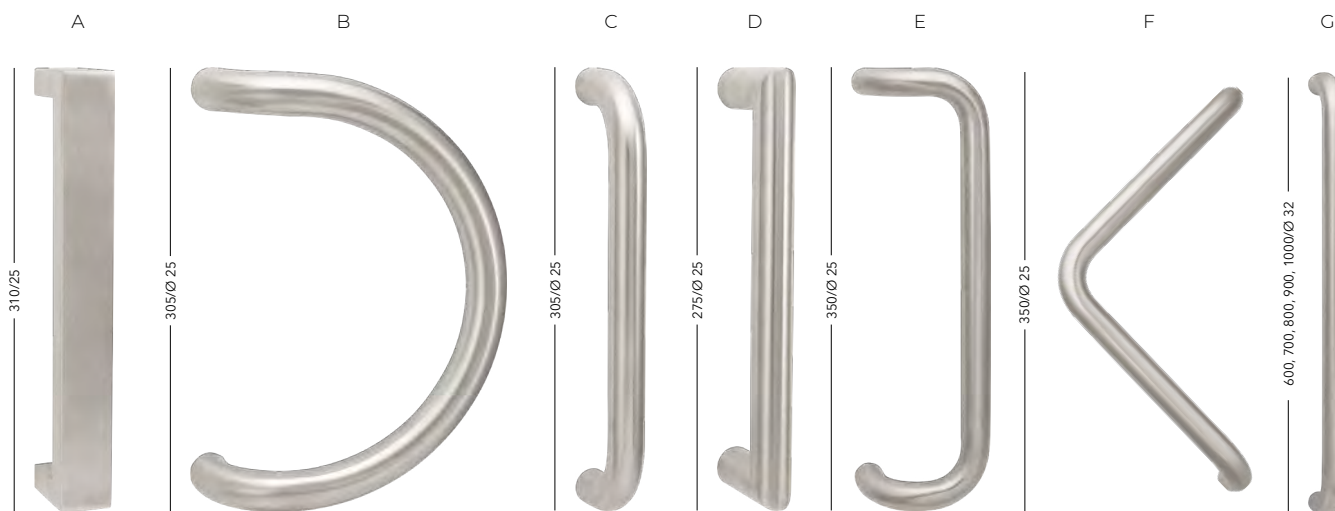

## Madla

### Madlo 643 nerez

Povrch	typ provedení	obj. číslo kus	CZK	s DPH	EUR	s DPH
IN	celková délka 400	CVX0643EMA0400	1960,0	2371,6	76,9	93,0
IN	celková délka 500	CVX0643EMA0500	2130,0	2577,3	83,5	101,1
IN	celková délka 600	CVX0643EMA0600	2410,0	2916,1	94,5	114,4
IN	celková délka 800	CVX0643EMA0800	2590,0	3133,9	101,6	122,9
IN	celková délka 1000	CVX0643EMA1000	2880,0	3484,8	112,9	136,7
IN	celková délka 1200	CVX0643EMA1200	3110,0	3763,1	122,0	147,6
IN	celková délka 1500	CVX0643EMA1500	3280,0	3968,8	128,6	155,6
IN	celková délka 1600	CVX0643EMA1600	3510,0	4247,1	137,6	166,6
IN	celková délka 1800	CVX0643EMA1800	3680,0	4452,8	144,3	174,6
IN	celková délka 2000	CVX0643EMA2000	3970,0	4803,7	155,7	188,4



# Madla



## Madlo 919 matná černá

Povrch	typ provedení	obj.	číslo kus	CZK	s DPH	EUR	s DPH
Č.ANT	celková délka	400	CVX0919BMA0400	4370,0	5287,7	171,4	207,4
Č.ANT	celková délka	500	CVX0919BMA0500	4950,0	5989,5	194,1	234,9
Č.ANT	celková délka	600	CVX0919BMA0600	5350,0	6473,5	209,8	253,9
Č.ANT	celková délka	800	CVX0919BMA0800	5520,0	6679,2	216,5	261,9
Č.ANT	celková délka	1000	CVX0919BMA1000	7480,0	9050,8	293,3	354,9
Č.ANT	celková délka	1200	CVX0919BMA1200	7890,0	9546,9	309,4	374,4

## Madlo 919 nerez

Povrch	typ provedení	obj.	číslo kus	CZK	s DPH	EUR	s DPH
IN	celková délka	400	CVX0919EMA0400	4030,0	4876,3	158,0	191,2
IN	celková délka	500	CVX0919EMA0500	4370,0	5287,7	171,4	207,4
IN	celková délka	600	CVX0919EMA0600	4540,0	5493,4	178,0	215,4
IN	celková délka	800	CVX0919EMA0800	4950,0	5989,5	194,1	234,9
IN	celková délka	1000	CVX0919EMA1000	6790,0	8215,9	266,3	322,2
IN	celková délka	1200	CVX0919EMA1200	7250,0	8772,5	284,3	344,0



## Madlo 1031 matná černá

Povrch	typ provedení	obj.	číslo kus	CZK	s DPH	EUR	s DPH
Č.ANT	celková délka	400	CVX1031BMA0400	2590,0	3133,9	101,6	122,9
Č.ANT	celková délka	500	CVX1031BMA0500	2820,0	3412,2	110,6	133,8
Č.ANT	celková délka	600	CVX1031BMA0600	2990,0	3617,9	117,3	141,9
Č.ANT	celková délka	800	CVX1031BMA0800	3560,0	4307,6	139,6	168,9
Č.ANT	celková délka	1000	CVX1031BMA1000	4030,0	4876,3	158,0	191,2
Č.ANT	celková délka	1200	CVX1031BMA1200	4490,0	5432,9	176,1	213,1
Č.ANT	celková délka	1400	CVX1031BMA1500	4950,0	5989,5	194,1	234,9
Č.ANT	celková délka	1600	CVX1031BMA1600	5410,0	6546,1	212,2	256,7
Č.ANT	celková délka	1800	CVX1031BMA1800	5980,0	7235,8	234,5	283,8
Č.ANT	celková délka	2000	CVX1031BMA2000	6330,0	7659,3	248,2	300,4

## Madlo 1031 nikel matný

Povrch	typ provedení	obj.	číslo kus	CZK	s DPH	EUR	s DPH
ONS	celková délka	400	CVX10316MA0400	2410,0	2916,1	94,5	114,4
ONS	celková délka	500	CVX10316MA0500	2590,0	3133,9	101,6	122,9
ONS	celková délka	600	CVX10316MA0600	2730,0	3303,3	107,1	129,5
ONS	celková délka	800	CVX10316MA0800	2990,0	3617,9	117,3	141,9
ONS	celková délka	1000	CVX10316MA1000	3680,0	4452,8	144,3	174,6
ONS	celková délka	1200	CVX10316MA1200	4030,0	4876,3	158,0	191,2
ONS	celková délka	1400	CVX10316MA1500	4490,0	5432,9	176,1	213,1
ONS	celková délka	1600	CVX10316MA1600	4950,0	5989,5	194,1	234,9
ONS	celková délka	1800	CVX10316MA1800	5410,0	6546,1	212,2	256,7
ONS	celková délka	2000	CVX10316MA2000	5810,0	7030,1	227,8	275,7

## Madla



### Madlo 473

Povrch	typ provedení	obj. číslo kus	CZK	s DPH	EUR	s DPH
ONS	nikl matný	CVX04736MA	1240,0	1500,4	48,6	58,8
OS	mosaz matná	CVX04733MA	1240,0	1500,4	48,6	58,8
MOSA	mosaz antik	CVX0473AMA	1390,0	1681,9	54,5	66,0

### Madlo 627

Povrch	typ provedení	obj. číslo kus	CZK	s DPH	EUR	s DPH
ONS	nikl matný	CVX06276MA	1240,0	1500,4	48,6	58,8
OS	mosaz matná	CVX06273MA	1240,0	1500,4	48,6	58,8
MOSA	mosaz antik	CVX0627AMA	1390,0	1681,9	54,5	66,0

### Madlo 861

Povrch	typ provedení	obj. číslo kus	CZK	s DPH	EUR	s DPH
IN	nerez - levé	CVX0861LE	7300,0	8833,0	286,3	346,4
IN	nerez - pravé	CVX0861PE	7300,0	8833,0	286,3	346,4

### Madlo 883

Povrch	typ provedení	obj. číslo kus	CZK	s DPH	EUR	s DPH
ONS	celková délka 250	CVX08836MA0250	1960,0	2371,6	76,9	93,0
ONS	celková délka 500	CVX08836MA0500	3450,0	4174,5	135,3	163,7

### Madlo 931

Povrch	typ provedení	obj. číslo pár	CZK	s DPH	EUR	s DPH
IN	celková délka 400	CVX0931EMA0400	3680,0	4452,8	144,3	174,6
IN	celková délka 600	CVX0931EMA0600	4030,0	4876,3	158,0	191,2
IN	celková délka 800	CVX0931EMA0800	4950,0	5989,5	194,1	234,9

## Madla Bregenz

Povrch	typ provedení	obj. číslo kus	CZK	s DPH	EUR	s DPH
K	kované kování	HA85201	3005,0	3636,1	117,8	142,6

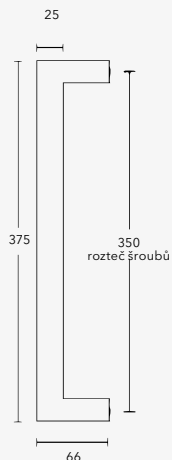

## Madla Stein

Povrch	typ provedení	obj. číslo kus	CZK	s DPH	EUR	s DPH
K	kované kování	HA280370	2925,0	3539,3	114,7	138,8

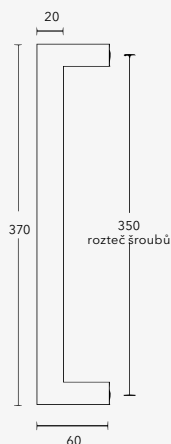

# Madlo „na míru“

## designový bezúdržbový způsob otevírání dveří

- zakázková nerezová madla
- volitelná délka a provedení
- profil 32mm, možné volit také hranaté provedení
- rozměry a cena mimo tabulku na vyžádání
- termín dodání 3 týdny

### Jednostranná madla

Model	Osový rozměr (rozteč) mm	Oblý roh CZK bez DPH	Oblý roh CZK s DPH	Oblý roh EUR bez DPH	Oblý roh EUR s DPH	Ostrý roh CZK bez DPH	Ostrý roh CZK s DPH	Ostrý roh EUR bez DPH	Ostrý roh EUR s DPH
"U" 501 - 600	mm 500 - 600	1950,0	2354,0	76,3	92,3	3175,0	3841,0	124,5	150,6
"U" 601 - 700	mm 601 - 700	2155,0	2602,0	84,3	102,0	3380,0	4088,0	132,5	160,3
"U" 701 - 800	mm 701 - 800	2360,0	2850,0	92,4	111,8	3585,0	4336,0	140,5	170,0
"U" 801 - 900	mm 801 - 900	2560,0	3097,0	100,4	121,5	3790,0	4584,0	148,6	179,8
"U" 901 - 1000	mm 901 - 1000	2765,0	3345,0	108,4	131,2	3995,0	4832,0	156,6	189,5
"U" 1001 - 1100	mm 1001 - 1100	2970,0	3593,0	116,4	140,9	4200,0	5079,0	164,6	199,2
"U" 1101 - 1200	mm 1101 - 1200	3175,0	3841,0	124,5	150,6	4405,0	5327,0	172,7	208,9
"U" 1201 - 1300	mm 1201 - 1300	3380,0	4088,0	132,5	160,3	4610,0	5575,0	180,7	218,6
"U" 1301 - 1400	mm 1301 - 1400	3585,0	4336,0	140,5	170,0	4815,0	5823,0	188,7	228,3
"U" 1401 - 1500	mm 1401 - 1500	3790,0	4584,0	148,6	179,8	5020,0	6070,0	196,7	238,1
"U" 1501 - 1600	mm 1501 - 1600	3995,0	4832,0	156,6	189,5	5225,0	6318,0	204,8	247,8
"U" 1601 - 1700	mm 1601 - 1700	4200,0	5079,0	164,6	199,2	5430,0	6566,0	212,8	257,5
"U" 1701 - 1800	mm 1701 - 1800	4405,0	5327,0	172,7	208,9	5635,0	6814,0	220,8	267,2
"U" 1801 - 1900	mm 1801 - 1900	4610,0	5575,0	180,7	218,6	5840,0	7061,0	228,9	276,9
"U" 1901 - 2000	mm 1901 - 2000	4815,0	5823,0	188,7	228,3	6045,0	7309,0	236,9	286,6

Model	Osový rozměr (rozteč) mm	CZK bez DPH	CZK s DPH	EUR bez DPH	EUR s DPH
"F1" 501 - 600	mm 301-400	3075,0	3716,0	120,4	145,7
"F1" 601 - 700	mm 401-500	3225,0	3902,0	126,5	153,0
"F1" 701 - 800	mm 501-600	3380,0	4088,0	132,5	160,3
"F1" 801 - 900	mm 604-700	3535,0	4274,0	138,5	167,6
"F1" 901 - 1000	mm 701-800	3690,0	4459,0	144,5	174,9
"F1" 1001 - 1100	mm 801-900	3840,0	4645,0	150,5	182,2
"F1" 1101 - 1200	mm 901-1000	3995,0	4832,0	156,6	189,5
"F1" 1201 - 1300	mm 1001-1100	4095,0	4955,0	160,6	194,3
"F1" 1301 - 1400	mm 1101 - 1200	4200,0	5079,0	164,6	199,2
"F1" 1401 - 1500	mm 1201 - 1300	4300,0	5203,0	168,6	204,0
"F1" 1501 - 1600	mm 1301 - 1400	4405,0	5327,0	172,7	208,9
"F1" 1601 - 1700	mm 1401 - 1500	4505,0	5450,0	176,6	213,7
"F1" 1701 - 1800	mm 1501 - 1600	4610,0	5575,0	180,7	218,6
"F1" 1801 - 1900	mm 1601 - 1700	4710,0	5698,0	184,7	223,5
"F1" 1901 - 2000	mm 1701 - 1800	4815,0	5823,0	188,7	228,3



# Madlo „na míru“

## Oboustranná madla

Model	Osový rozměr (rozteč) mm	Oblý roh CZK bez DPH	Oblý roh CZK s DPH	Oblý roh EUR bez DPH	Oblý roh EUR s DPH	Ostrý roh CZK bez DPH	Ostrý roh CZK s DPH	Ostrý roh EUR bez DPH	Ostrý roh EUR s DPH
"U" 501 - 600 mm	500 - 600	2595,0	3138,0	101,7	123,1	4235,0	5120,0	165,9	200,8
"U" 601 - 700 mm	601 - 700	2870,0	3468,0	112,4	136,0	4505,0	5451,0	176,6	213,7
"U" 701 - 800 mm	701 - 800	3140,0	3799,0	123,1	149,0	4780,0	5781,0	187,4	226,7
"U" 801 - 900 mm	801 - 900	3415,0	4130,0	133,8	161,9	5055,0	6111,0	198,1	239,6
"U" 901 - 1000 mm	901 - 1000	3690,0	4459,0	144,5	174,9	5325,0	6442,0	208,8	252,6
"U" 1001 - 1100 mm	1001 - 1100	3960,0	4790,0	155,2	187,8	5600,0	6771,0	219,5	265,5
"U" 1101 - 1200 mm	1101 - 1200	4235,0	5120,0	165,9	200,8	5870,0	7102,0	230,2	278,5
"U" 1201 - 1300 mm	1201 - 1300	4505,0	5451,0	176,6	213,7	6145,0	7433,0	240,9	291,5
"U" 1301 - 1400 mm	1301 - 1400	4780,0	5781,0	187,4	226,7	6420,0	7763,0	251,6	304,4
"U" 1401 - 1500 mm	1401 - 1500	5055,0	6111,0	198,1	239,6	6690,0	8093,0	262,3	317,4
"U" 1501 - 1600 mm	1501 - 1600	5325,0	6442,0	208,8	252,6	6965,0	8423,0	273,0	330,3
"U" 1601 - 1700 mm	1601 - 1700	5600,0	6771,0	219,5	265,5	7235,0	8754,0	283,7	343,3
"U" 1701 - 1800 mm	1701 - 1800	5870,0	7102,0	230,2	278,5	7510,0	9085,0	294,4	356,3
"U" 1801 - 1900 mm	1801 - 1900	6145,0	7433,0	240,9	291,5	7785,0	9414,0	305,1	369,2
"U" 1901 - 2000 mm	1901 - 2000	6420,0	7763,0	251,6	304,4	8055,0	9745,0	315,8	382,2

Model	Osový rozměr (rozteč) mm	CZK bez DPH	CZK s DPH	EUR bez DPH	EUR s DPH
"F1" 501 - 600 mm	301-400	4 095,0	4 955,0	160,6	194,3
"F1" 601 - 700 mm	401-500	4 300,0	5 203,0	168,6	204,0
"F1" 701 - 800 mm	501-600	4 505,0	5 451,0	176,6	213,7
"F1" 801 - 900 mm	604-700	4 710,0	5 698,0	184,7	223,5
"F1" 901 - 1000 mm	701-800	4 915,0	5 946,0	192,7	233,2
"F1" 1001 - 1100 mm	801-900	5 120,0	6 194,0	200,7	242,9
"F1" 1101 - 1200 mm	901-1000	5 325,0	6 442,0	208,8	252,6
"F1" 1201 - 1300 mm	1001-1100	5 460,0	6 607,0	214,1	259,1
"F1" 1301 - 1400 mm	1101 - 1200	5 600,0	6 771,0	219,5	265,5
"F1" 1401 - 1500 mm	1201 - 1300	5 735,0	6 937,0	224,8	272,1
"F1" 1501 - 1600 mm	1301 - 1400	5 870,0	7 102,0	230,2	278,5
"F1" 1601 - 1700 mm	1401 - 1500	6 010,0	7 267,0	235,5	285,0
"F1" 1701 - 1800 mm	1501 - 1600	6 145,0	7 433,0	240,9	291,5
"F1" 1801 - 1900 mm	1601 - 1700	6 280,0	7 598,0	246,2	298,0
"F1" 1901 - 2000 mm	1701 - 1800	6 420,0	7 763,0	251,6	304,4



## Posuvný systém

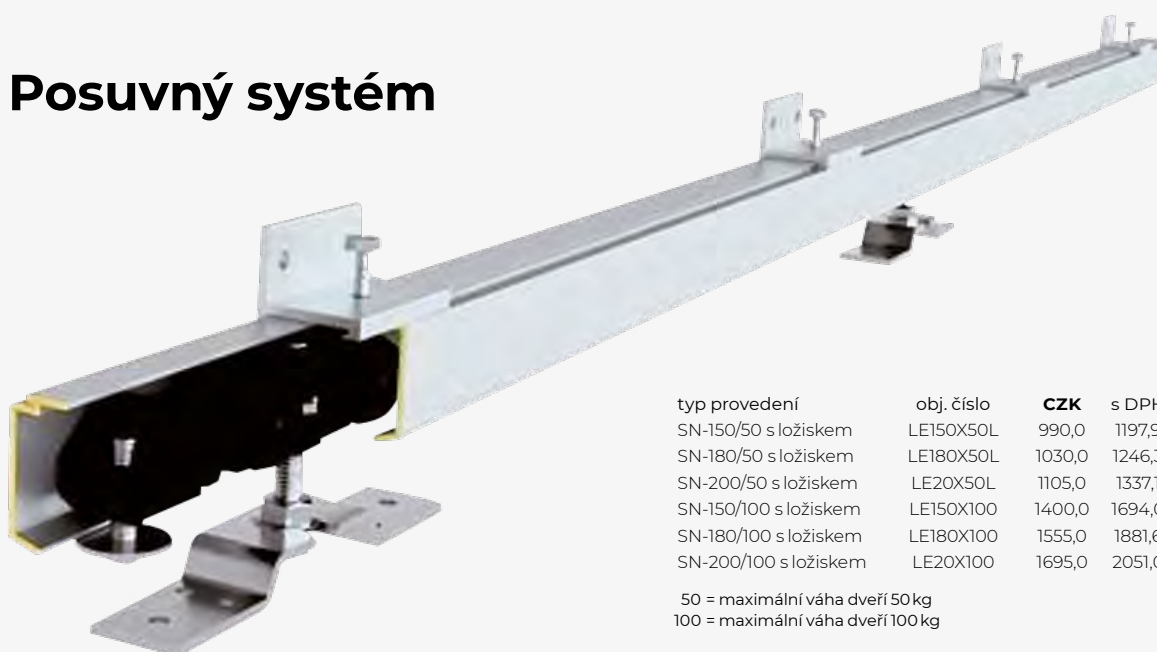

typ provedení	obj. číslo	CZK	s DPH	EUR	s DPH
SN-150/50 s ložiskem	LE150X50L	990,0	1197,9	38,8	47,0
SN-180/50 s ložiskem	LE180X50L	1030,0	1246,3	40,4	48,9
SN-200/50 s ložiskem	LE20X50L	1105,0	1337,1	43,3	52,4
SN-150/100 s ložiskem	LE150X100	1400,0	1694,0	54,9	66,4
SN-180/100 s ložiskem	LE180X100	1555,0	1881,6	61,0	73,8
SN-200/100 s ložiskem	LE20X100	1695,0	2051,0	66,5	80,4

50 = maximální váha dveří 50 kg  
100 = maximální váha dveří 100 kg

## Náprstky MT, MQ

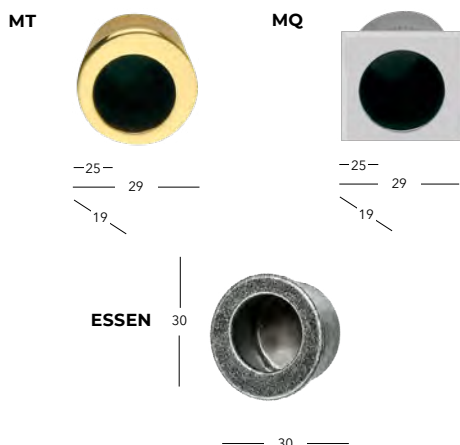

cena za kus

Povrch typ provedení	obj. číslo	CZK	s DPH	EUR	s DPH
<b>OCS</b> Náprstek MT kulatá	P14909X03N	100,0	121,0	3,9	4,7
<b>OC</b> Náprstek MT kulatá	P14905X03N	100,0	121,0	3,9	4,7
<b>OFS</b> Náprstek MT kulatá	P14908X03N	100,0	121,0	3,9	4,7
<b>OLV</b> Náprstek MT kulatá	P14902X03N	100,0	121,0	3,9	4,7
<b>OCS</b> Náprstek MQ hranatá	P14909HX03N	110,0	133,1	4,3	5,2
<b>OC</b> Náprstek MQ hranatá	P14905HX03N	110,0	133,1	4,3	5,2
<b>OLV</b> Náprstek MQ hranatá	P14902HX03N	110,0	133,1	4,3	5,2
<b>K</b> Náprstek Essen	HA37000	380,0	459,8	14,9	18,0

## Úchyt 3663

Narážecí ovál

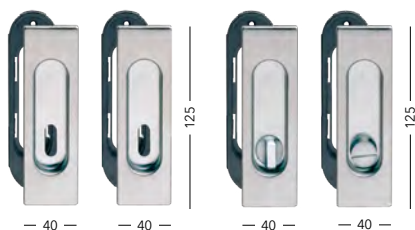

Pružinová bez otvoru



Povrch typ provedení	obj. číslo	CZK	s DPH	EUR	s DPH
<b>ČERNÁ</b> 3663 bez otvoru pár	P1790BPAR	530,0	641,3	20,8	25,1
<b>IN</b> 3663 bez otvoru pár	P1790EHX03PAR	530,0	641,3	20,8	25,1
<b>OCS</b> 3663 bez otvoru pár	P17909HX03PAR	530,0	641,3	20,8	25,1
<b>OC</b> 3663 bez otvoru pár	P17905HX03PAR	530,0	641,3	20,8	25,1
<b>ONS</b> 3663 bez otvoru pár	P17906HX03PAR	530,0	641,3	20,8	25,1
<b>OFS</b> 3663 bez otvoru pár	P17908HX03PAR	530,0	641,3	20,8	25,1
<b>OLV</b> 3663 bez otvoru pár	P17902HX03PAR	530,0	641,3	20,8	25,1
<b>OCS</b> 3663 BB pár	P17909HX13PAR	545,0	659,5	21,4	25,9
<b>OC</b> 3663 BB pár	P17905HX13PAR	545,0	659,5	21,4	25,9
<b>ONS</b> 3663 BB pár	P17906HX13PAR	545,0	659,5	21,4	25,9
<b>OFS</b> 3663 BB pár	P17908HX13PAR	545,0	659,5	21,4	25,9
<b>OLV</b> 3663 BB pár	P16902HX13PAR	545,0	659,5	21,4	25,9
<b>OCS</b> 3663 WC set	P17909HX3312PAR	795,0	962,0	31,2	37,7
<b>OC</b> 3663 WC set	P17905HX3312PAR	795,0	962,0	31,2	37,7
<b>ONS</b> 3663 WC set	P17906HX3312PAR	795,0	962,0	31,2	37,7
<b>OFS</b> 3663 WC set	P17908HX3312PAR	795,0	962,0	31,2	37,7
<b>OLV</b> 3663 WC set	P17902HX3312PAR	795,0	962,0	31,2	37,7
<b>OCS</b> 3663 pruž. bez otv. pár	P17909HPRX03PAR	900,0	1089,0	35,3	42,7
<b>OC</b> 3663 pruž. bez otv. pár	P17905HPRX03PAR	900,0	1089,0	35,3	42,7
<b>ONS</b> 3663 pruž. bez otv. pár	P17906HPRX03PAR	900,0	1089,0	35,3	42,7
<b>OFS</b> 3663 pruž. bez otv. pár	P17908HPRX03PAR	900,0	1089,0	35,3	42,7
<b>OLV</b> 3663 pruž. bez otv. pár	P17902PRX03PAR	900,0	1089,0	35,3	42,7

## Úchyt 3665

Narážecí ovál

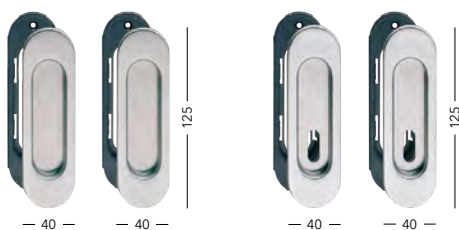

Povrch typ provedení	obj. číslo	CZK	s DPH	EUR	s DPH
<b>ČERNÁ</b> 3665 bez otvoru pár	P1790BX03PAR	460,0	556,6	18,0	21,8
<b>OFS</b> 3665 bez otvoru pár	P17908X03PAR	460,0	556,6	18,0	21,8
<b>IN</b> 3665 bez otvoru pár	P1790EX03PAR	460,0	556,6	18,0	21,8
<b>OCS</b> 3665 bez otvoru pár	P17909X03PAR	460,0	556,6	18,0	21,8
<b>OC</b> 3665 bez otvoru pár	P17905X03PAR	460,0	556,6	18,0	21,8
<b>OLV</b> 3665 bez otvoru pár	P17902X03PAR	460,0	556,6	18,0	21,8
<b>OCS</b> 3665 BB pár	P17909X23PAR	475,0	574,8	18,6	22,5
<b>OC</b> 3665 BB pár	P17905X23PAR	475,0	574,8	18,6	22,5
<b>ONS</b> 3665 BB pár	P17906X23PAR	475,0	574,8	18,6	22,5
<b>OFS</b> 3665 BB pár	P17908X23PAR	475,0	574,8	18,6	22,5
<b>OLV</b> 3665 BB pár	P17902X23PAR	475,0	574,8	18,6	22,5
<b>OCS</b> 3665 WC set	P17909X3312PAR	760,0	919,6	29,8	36,1
<b>OC</b> 3665 WC set	P17905X3312PAR	760,0	919,6	29,8	36,1
<b>ONS</b> 3665 WC set	P17906X3312PAR	760,0	919,6	29,8	36,1
<b>OFS</b> 3665 WC set	P17908X3312PAR	760,0	919,6	29,8	36,1
<b>OLV</b> 3665 WC set	P17902X3312PAR	760,0	919,6	29,8	36,1
<b>OCS</b> 3665 pruž. bez otv. pár	P17909PRX03PAR	840,0	1016,4	32,9	39,9
<b>OC</b> 3665 pruž. bez otv. pár	P17905PRX03PAR	840,0	1016,4	32,9	39,9
<b>ONS</b> 3665 pruž. bez otv. pár	P17906PRX03PAR	840,0	1016,4	32,9	39,9
<b>OFS</b> 3665 pruž. bez otv. pár	P17908PRX03PAR	840,0	1016,4	32,9	39,9
<b>OLV</b> 3665 pruž. bez otv. pár	P17902PRX03PAR	840,0	1016,4	32,9	39,9

## Úchyt 3666 Kulatá

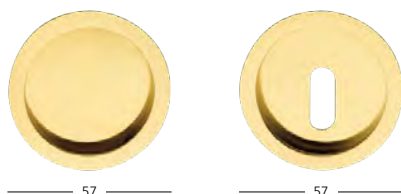

Povrch	typ provedení	obj. číslo	CZK	s DPH	EUR	s DPH
OC	3666 bez otvoru pár	P16909X03PAR	315,0	381,2	12,4	14,9
OC	3666 bez otvoru pár	P16905X03PAR	315,0	381,2	12,4	14,9
ONS	3666 bez otvoru pár	P16906X03PAR	315,0	381,2	12,4	14,9
OFS	3666 bez otvoru pár	P16908X03PAR	315,0	381,2	12,4	14,9
OLV	3666 bez otvoru pár	P16902X03PAR	315,0	381,2	12,4	14,9
OC	3666 BB pár	P16909X13PAR	345,0	417,5	13,5	16,4
OC	3666 BB pár	P16905X13PAR	345,0	417,5	13,5	16,4
ONS	3666 BB pár	P16906X13PAR	345,0	417,5	13,5	16,4
OFS	3666 BB pár	P16908X13PAR	345,0	417,5	13,5	16,4
OLV	3666 BB pár	P16902X13PAR	345,0	417,5	13,5	16,4
OC	3666 WC set	P16909X3312PAR	545,0	659,5	21,4	25,9
OC	3666 WC set	P16905X3312PAR	545,0	659,5	21,4	25,9
ONS	3666 WC set	P16906X3312PAR	545,0	659,5	21,4	25,9
OFS	3666 WC set	P16908X3312PAR	545,0	659,5	21,4	25,9
OLV	3666 WC set	P16902X3312PAR	545,0	659,5	21,4	25,9

## Úchyt 3667 Hranatá



Povrch	typ provedení	obj. číslo	CZK	s DPH	EUR	s DPH
OC	3667 bez otvoru pár	P16909HX03PAR	405,0	490,1	15,9	19,2
OC	3667 bez otvoru pár	P16905HX03PAR	405,0	490,1	15,9	19,2
ONS	3667 bez otvoru pár	P16906HX03PAR	405,0	490,1	15,9	19,2
OFS	3667 bez otvoru pár	P16908HX03PAR	405,0	490,1	15,9	19,2
OLV	3667 bez otvoru pár	P16902HX03PAR	405,0	490,1	15,9	19,2
OC	3667 BB pár	P16909HX13PAR	440,0	532,4	17,3	20,9
OC	3667 BB pár	P16905HX13PAR	440,0	532,4	17,3	20,9
ONS	3667 BB pár	P16906HX13PAR	440,0	532,4	17,3	20,9
OFS	3667 BB pár	P16908HX13PAR	440,0	532,4	17,3	20,9
OLV	3667 BB pár	P16902HX13PAR	440,0	532,4	17,3	20,9
OC	3667 WC set	P16909HX3312PAR	610,0	738,1	23,9	28,9
OC	3667 WC set	P16905HX3312PAR	610,0	738,1	23,9	28,9
ONS	3667 WC set	P16906HX3312PAR	610,0	738,1	23,9	28,9
OFS	3667 WC set	P16908HX3312PAR	610,0	738,1	23,9	28,9
OLV	3667 WC set	P16902HX3312PAR	610,0	738,1	23,9	28,9

## Úchyty

cena za kus

Povrch	typ provedení	obj. číslo	CZK	s DPH	EUR	s DPH
IN	Úchyt pos. dveře A	C160EXA	250,0	302,5	9,8	11,9
IN	Úchyt pos. dveře B	C160EXB	165,0	199,7	6,5	7,8
IN	Úchyt pos. dveře C	C160EXC	175,0	211,8	6,9	8,3
IN	Úchyt pos. dveře D	C160EXD	375,0	453,8	14,7	17,8
IN	Úchyt pos. dveře E	C160EXE	165,0	199,7	6,5	7,8

posuvné dveře A

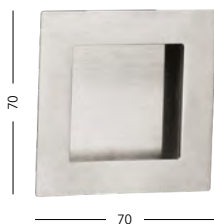

posuvné dveře B

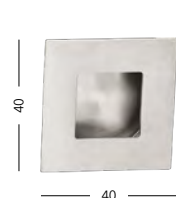

posuvné dveře C



posuvné dveře D

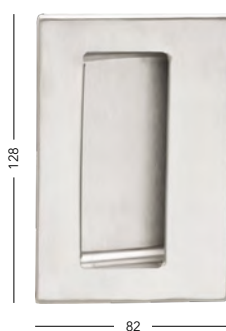

posuvné dveře E



# Úchytky

Hloubka 12 mm

Hranatá bez otvoru



Ovál bez otvoru



Ovál WC vnitřní



Ovál BB



Ovál WC vnější



Hranatá bez otvoru



cena za kus

Povrch typ provedení	obj. číslo	CZK	s DPH	EUR	s DPH
<b>IN</b> Hranatá bez otvoru	C1592EX03	235,0	284,4	9,2	11,2
<b>IN</b> Ovál bez otvoru	C1591EX03	235,0	284,4	9,2	11,2
<b>OCS</b> Ovál bez otvoru	P15909X03P	265,0	320,7	10,4	12,6
<b>OC</b> Ovál bez otvoru	P15905X03P	265,0	320,7	10,4	12,6
<b>ONS</b> Ovál bez otvoru	P15906X03P	265,0	320,7	10,4	12,6
<b>OFS</b> Ovál bez otvoru	P15907X03P	265,0	320,7	10,4	12,6
<b>OLV</b> Ovál bez otvoru	P15902X03P	265,0	320,7	10,4	12,6
<b>OCS</b> Ovál BB	P15909X13P	265,0	320,7	10,4	12,6
<b>OC</b> Ovál BB	P15905X13P	265,0	320,7	10,4	12,6
<b>ONS</b> Ovál BB	P15906X13P	265,0	320,7	10,4	12,6
<b>OFS</b> Ovál BB	P15907X13P	265,0	320,7	10,4	12,6
<b>OLV</b> Ovál BB	P15902X13P	265,0	320,7	10,4	12,6
<b>OCS</b> Ovál WC vnitřní	P15909X331P	380,0	459,8	14,9	18,0
<b>OCS</b> Ovál WC vnější	P15909X332P	380,0	459,8	14,9	18,0
<b>OC</b> Ovál WC vnitřní	P15905X331P	380,0	459,8	14,9	18,0
<b>OC</b> Ovál WC vnější	P15905X332P	380,0	459,8	14,9	18,0
<b>ONS</b> Ovál WC vnitřní	P15906X331P	380,0	459,8	14,9	18,0
<b>ONS</b> Ovál WC vnější	P15906X332P	380,0	459,8	14,9	18,0
<b>OFS</b> Ovál WC vnitřní	P15907X331P	380,0	459,8	14,9	18,0
<b>OFS</b> Ovál WC vnější	P15907X332P	380,0	459,8	14,9	18,0
<b>OLV</b> Ovál WC vnitřní	P15902X331P	380,0	459,8	14,9	18,0
<b>OLV</b> Ovál WC vnější	P15902X332P	380,0	459,8	14,9	18,0

cena za kus

Povrch typ provedení	obj. číslo	CZK	s DPH	EUR	s DPH
<b>IN</b> Úchytky 120x50mm bez otvoru	A23601	180,0	218,0	7,7	9,2
<b>IN</b> Úchytky 150x50mm bez otvoru	A23602	205,0	248,0	8,7	10,4
<b>IN</b> Úchytky 180x60mm bez otvoru	A23603	230,0	278,0	9,8	11,8

# Úchytky Kované

cena za kus

Povrch typ provedení	obj. číslo	CZK	s DPH	EUR	s DPH
<b>K</b> Ovál 001	HA217001	380,0	459,8	14,9	18,0
<b>K</b> Ovál 003	HA217003	460,0	556,6	18,0	21,8
<b>K</b> Ovál 004	HA217004	460,0	556,6	18,0	21,8
<b>K</b> Nurnberg ovál	HA36000	575,0	695,8	22,5	27,3
<b>K</b> Ulmen hranatý	HA300UCH	1005,0	1216,1	39,4	47,7

001



003



004



Nurnberg



Ulmen

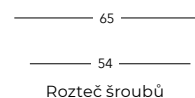



# DOPLŇKY

## Doplňky

### ACCESSORIES

- |     |                                 |     |                                |     |                  |
|-----|---------------------------------|-----|--------------------------------|-----|------------------|
| 138 | Balkónové kliky                 | 148 | Drobný spojovací materiál      | 155 | Vhozy na dopisy  |
| 139 | Kovaná posuvná klika Steinacht  | 149 | Krbové nářadí / Dětský program | 156 | Věšáky a konzole |
| 140 | Cylindrické vložky              | 150 | Panikové kování                | 158 | Zadlabací zámky  |
| 144 | Číslice a piktogramy / klepadla | 152 | Rozety / montážní šablony      | 159 | Závěsy           |
| 146 | Dorazy, stavěče, zarážky        | 153 | Prahové lišty                  | 164 | Kování na sklo   |
| 147 | Řetízky, kukátka                | 154 | Samozavírače                   |     |                  |
| 148 | Držáky zábradlí                 | 155 | Větrací mřížky                 |     |                  |





# Balkónové kliky

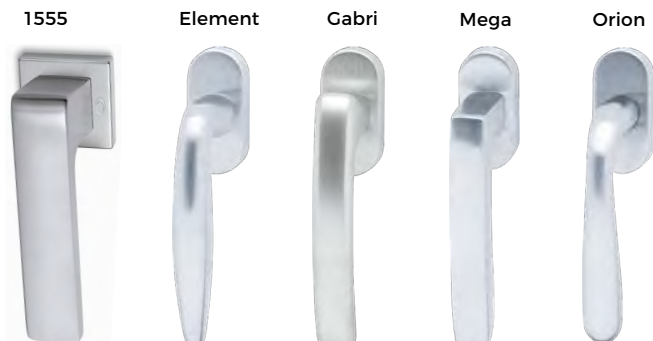

Název	CZK	s DPH	EUR	s DPH
1555	1820,0	2202,2	71,4	86,4
Element	425,0	514,3	16,7	20,2
Gabri	585,0	707,9	22,9	27,8
Mega	480,0	580,8	18,8	22,8
Orion	365,0	441,7	14,3	17,3

„Informujte se u vašeho prodejce na možnost kompletace balkonové kliky z jakékoliv interiérové v tomto katalogu dle vašeho výběru“



Název	CZK	s DPH	EUR	s DPH
ST1	150,0	182,0	5,9	7,1
ST5-F1	120,0	139,0	4,7	5,6
ST5-F1 pojistka	400,0	484,0	15,7	18,8
ST5-F1 uzamykatelná	490,0	593,0	19,2	23,1
ST5-F4	130,0	157,0	5,1	6,1
ST5-F4 pojistka	440,0	532,0	17,3	20,7
ST5-F4 uzamykatelná	490,0	593,0	19,2	23,1
ST5-F9	130,0	157,0	5,1	6,1
ST5-F9 pojistka	440,0	532,0	17,3	20,7
ST5-F9 uzamykatelná	490,0	593,0	19,2	23,1



Název	CZK	s DPH	EUR	s DPH
ST6-antracit	90,0	109,0	3,5	4,2
ST6-bílá	70,0	85,0	2,7	3,3
ST6-bílá uzamykatelná	220,0	266,0	8,6	10,4
ST6-hnědá	70,0	85,0	2,7	3,3
ST6-satén	90,0	109,0	3,5	4,2
ST6-titan	90,0	109,0	3,5	4,2
ST6-zlatá	90,0	109,0	3,5	4,2
ST6-zlatý dub	90,0	109,0	3,5	4,2
ST7-bílá	60,0	73,0	2,4	2,8
ST8-bílá plast	40,0	48,0	1,6	1,9



## Balkónové kliky

Innsbruck HR



Innsbruck HR se zámkem



Innsbruck OVÁL



Innsbruck OVÁL se zámkem



Název	CZK	s DPH	EUR	s DPH
Innsbruck HR	2290,0	2770,9	89,8	108,7
Innsbruck HR se zámkem	4155,0	5027,6	162,9	197,2
Innsbruck OVÁL	2290,0	2770,9	89,8	108,7
Innsbruck OVÁL se zámkem	4155,0	5027,6	162,9	197,2

K

## Kovaná posuvná klika / mušle

Steinacht



120

40

10

CZK	s DPH	EUR	s DPH
7820,0	9462,2	306,7	371,1

K

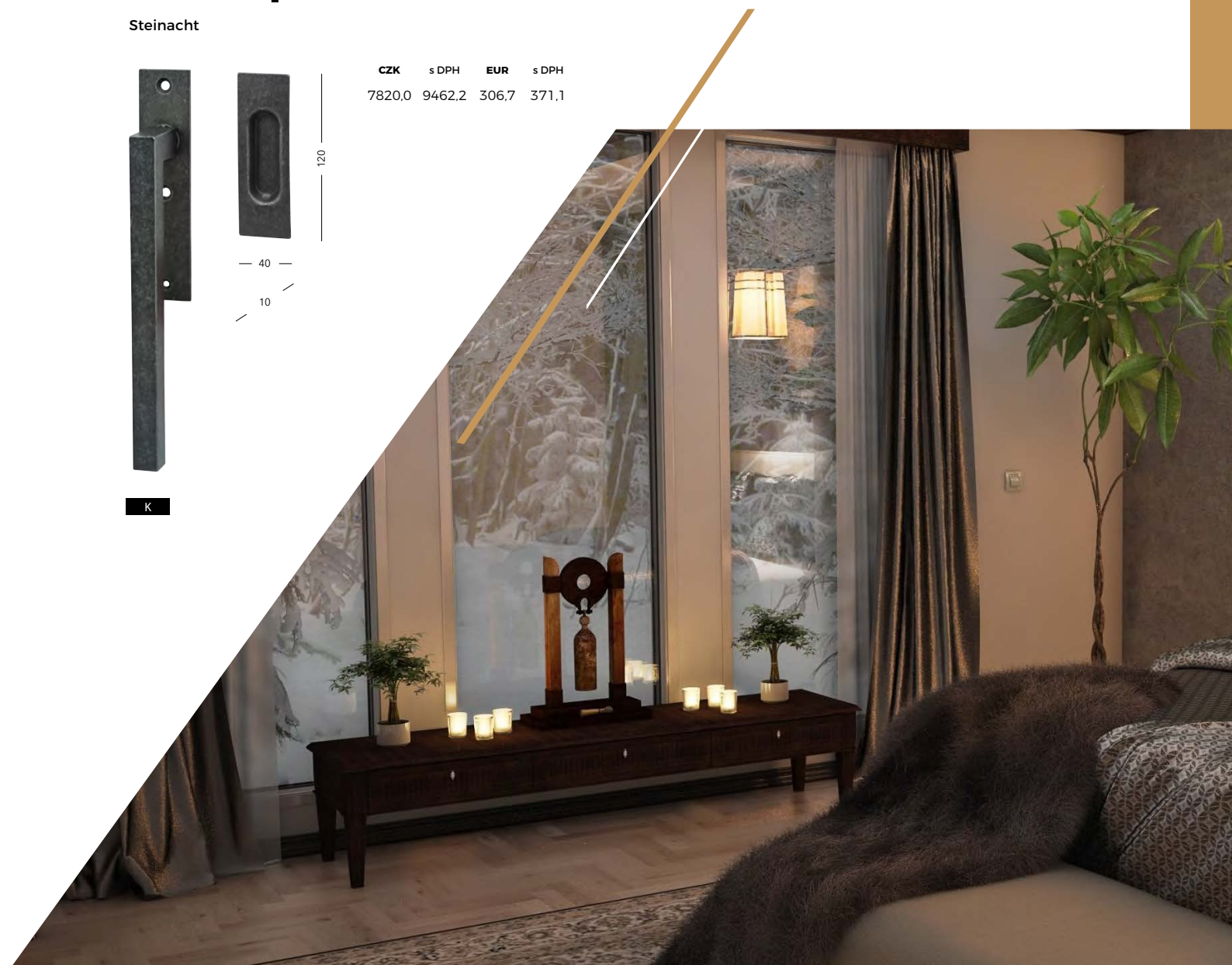

# Cylindrické vložky

## EURO X Star



Certifikováno v bezpečnostní třídě RC4 dle ČSN EN 1627:2012.

Bezpečnostní 10-ti stavítková vložka s ocelovou tyčí proti rozlomení. Ochrana proti vyhmátání a bumpingu. Možnost společného uzávěru - SU.

430.000 reálných kombinací klíče.

Materiál vložky a klíče: **mosaz**  
Povrchová úprava: **nikl matný**

### Obsahuje:

6 ks prodloužených oboustraných klíčů  
2 ks šroubů 50+60mm  
identifikační kartu



Možnost objednání s knoflíkem.

## EURO Secure



Certifikováno v bezpečnostní třídě RC3 dle ČSN EN 1627:2012.

Certifikát NBÚ typ 2SS4=2

Bezpečnostní 6-ti stavítková vložka s odolností proti odvrtání a nedestruktivní dynamické metodě (tzv. bumping) Možnost společného uzávěru - SU.

40.000 reálných kombinací klíče.

Materiál vložky a klíče: **mosaz**  
Povrchová úprava: **nikl matný, mosaz matná**

### Obsahuje:

6 ks prodloužených klíčů  
2 ks šroubů 50+60mm  
identifikační kartu



Možnost objednání s knoflíkem.

## EURO Plus

Certifikováno dle EN 1303:2005.

Stavební 5-ti stavítková vložka.

Materiál vložky a klíče: **mosaz**

Povrchová úprava: **nikl matný**

Možnost společného uzávěru - SU.

### Obsahuje:

3 ks klíčů  
2 ks šroubů 50+60mm



Možnost objednání s knoflíkem.

## EURO Zero

### Stavební 5 stavítková vložka

Materiál vložky a klíče: **slitina zinku**

Povrchová úprava: **nikl matný**

Možnost společného uzávěru - SU.

### Obsahuje:

3 ks klíčů  
1 ks šroubů 50 mm



## CZK / s DPH

Rozměr	30/30.NI	30/35.NI	30/35.MS	30/35.BR	30/40.NI	30/45.NI	30/50.NI	30/55.NI	30/60.NI	30/65.NI	30/70.NI	35/35.NI	35/40.NI	35/45.NI
<b>EURO XStar</b>	605/732	605/732	x	x	640/774	670/810	700/847	730/883	765/925	x	x	640/774	670/810	700/847
<b>EURO Secure</b>	305/369	340/411	305/369	x	340/411	360/435	370/447	400/484	420/508	445/538	465/562	340/411	360/435	380/459
<b>EURO Plus</b>	160/193	160/193	155/187	155/187	175/211	200/242	220/266	230/278	245/296	x	x	260/314	200/220	220/266
<b>EURO Zero</b>	x	105/127	105/127	x	x	x	x	x	x	x	x	x	x	x
Rozměr	35/50.NI	35/55.NI	35/60.IN	35/65.NI	40/40.NI	40/45.NI	40/50.NI	40/55.NI	40/60.NI	45/45.NI	45/50.IN	45/55.NI	50/50.NI	40/65.NI
<b>EURO XStar</b>	730/883	765/925	795/962	815/986	700/847	730/883	765/925	795/962	815/986	765/925	795/962	815/986	815/986	835/1010
<b>EURO Secure</b>	400/484	420/508	445/538	465/562	380/459	400/484	420/508	445/538	465/562	420/508	445/538	465/562	465/562	525/635
<b>EURO Plus</b>	245/296	260/314	x	x	230/278	245/296	260/314	275/332	x	260/314	275/332	x	x	x
Rozměr	40/70.NI	45/60.NI	45/70.NI	50/55.NI	50/60.NI	55/55.NI	55/60.MS	60/60.BR	0/30.NI					
<b>EURO XStar</b>	860/1040	835/1010	x	x	860/1040	x	x	x	x					
<b>EURO Secure</b>	550/665	525/635	570/689	525/635	550/665	550/665	570/689	590/713	265/320					
<b>EURO Plus</b>	x	x	x	x	x	x	x	x	145/175					

## EUR / s DPH

Rozměr	30/30.NI	30/35.NI	30/35.MS	30/35.BR	30/40.NI	30/45.NI	30/50.NI	30/55.NI	30/60.NI	30/65.NI	30/70.NI	35/35.NI	35/40.NI	35/45.NI
<b>EURO XStar</b>	23,7/28,7	23,7/28,7	x	x	25,1/30,4	26,3/31,8	27,5/33,2	28,6/34,6	30/36,3	x	x	25,1/30,4	26,3/31,8	27,5/33,2
<b>EURO Secure</b>	12,0/14,5	13,3/16,1	12,0/14,5	x	13,3/16,1	14,1/17,1	14,5/17,6	15,7/19,0	16,5/19,9	17,5/21,1	18,2/22,1	13,3/16,1	14,1/17,1	14,9/18,0
<b>EURO Plus</b>	6,3/7,6	6,3/7,6	6,1/7,4	6,1/7,4	6,9/8,3	7,8/9,5	8,6/10,4	9,0/10,9	9,6/11,6	x	x	10,2/12,3	7,8/9,5	8,6/10,4
<b>EURO Zero</b>	x	4,1/5,0	4,1/5,0	x	x	x	x	x	x	x	x	x	x	x
Rozměr	35/50.NI	35/55.NI	35/60.IN	35/65.NI	40/40.NI	40/45.NI	40/50.NI	40/55.NI	40/60.NI	45/45.NI	45/50.IN	45/55.NI	50/50.NI	40/65.NI
<b>EURO XStar</b>	28,6/34,6	30,0/36,3	31,2/37,7	32,0/38,7	27,5/33,2	28,6/34,6	30,0/36,3	31,2/37,7	32,0/38,7	32,0/38,7	30,0/36,3	32,0/38,7	32,0/38,7	32,7/39,6
<b>EURO Secure</b>	15,7/19,0	16,5/19,9	17,5/21,1	18,2/22,1	14,9/18,0	15,7/19,0	16,5/19,9	17,5/21,1	18,2/22,1	16,5/19,9	17,5/21,1	18,2/22,1	18,2/22,1	20,6/24,9
<b>EURO Plus</b>	9,6/11,6	10,2/12,3	x	x	9,0/10,9	9,6/11,6	10,2/12,3	10,8/13,0	x	10,2/12,3	10,8/13,0	x	x	x
Rozměr	40/70.NI	45/60.NI	45/70.NI	50/55.NI	50/60.NI	55/55.NI	55/60.MS	60/60.BR	0/30.NI					
<b>EURO XStar</b>	33,7/40,8	32,7/39,6	x	x	33,7/40,8	x	x	x	x					
<b>EURO Secure</b>	21,6/26,1	20,6/24,9	22,4/27,0	20,6/24,9	21,6/26,1	21,6/26,1	22,4/27,0	23,1/28,0	10,4/12,6					
<b>EURO Plus</b>	x	x	x	x	x	x	x	x	5,7/6,9					

## Příplatky za přestavbu

	knoflík	přestavba	PS	klíč
<b>Euro zero</b>	x	x	x	39
<b>Euro minus</b>	x	200	x	39
<b>Euro plus</b>	260	200	x	39
<b>Euro secure</b>	260	220	260	59
<b>Euro xstar</b>	260	250	260	160

Knoflík - ani jedna strana nesmí být delší než 55mm.

PS - Prostupová spojka je doplňkový mechanismus vložky, který umožňuje ovládat vložku, i když je na protilehlé straně zasunutý klíč. Ani jedna strana nesmí být delší než 55mm.

## Vložka STAR

Kód	název	Kč bez DPH	Kč s DPH	€ bez DPH	€ s DPH
<b>HB30356STAR</b>	Vložka STAR 70S 30/35 R1 černá	615,-	744,-	24,1	28,9
<b>HB30406STAR</b>	Vložka STAR 70S 30/40 R1 černá	649,-	785,-	25,5	30,6
<b>HB30356STARKN</b>	Vložka STAR 70S 30/35K R1 černá KN	870,-	1053,-	34,1	40,9
<b>HB30406STARKN</b>	Vložka STAR 70S 30/40K R1 černá KN	890,-	1077,-	34,9	41,9

## System generálního klíče

System generálního klíče je způsob zabezpečení objektu, ve kterém je požadavek na omezení práv přístupu a je hojně využíván tam, kde je nutné přidělit prostřednictvím klíčových práv přístup do jednotlivých prostor daného objektu. V rámci systému generálního klíče obdrží každá osoba klíč, kterým si odemkne pouze přidělené vložky a zároveň neodemkne vložky, které přidělené nemá. V rámci systému generálního klíče se ale vždy generuje i zvláštní tzv. generální klíč, který odemkne veškeré zámky systému a který se používá při nenadálých situacích. Investor **specifikuje typ, rozměr a přístupová práva** k jednotlivým vstupům do elektronické tabulky.

Systemy generálního klíče se doporučují zejména pro použití v administrativních budovách, hotelích, sportovních centrech apod.

- generálním klíčem je možné otevřít všechny vložky v systému,
- hlavní klíč je klíč, kterým je možné otevřít určitou skupinu dveří,
- vlastní klíč otevírá pouze jednu cylindrickou vložku.

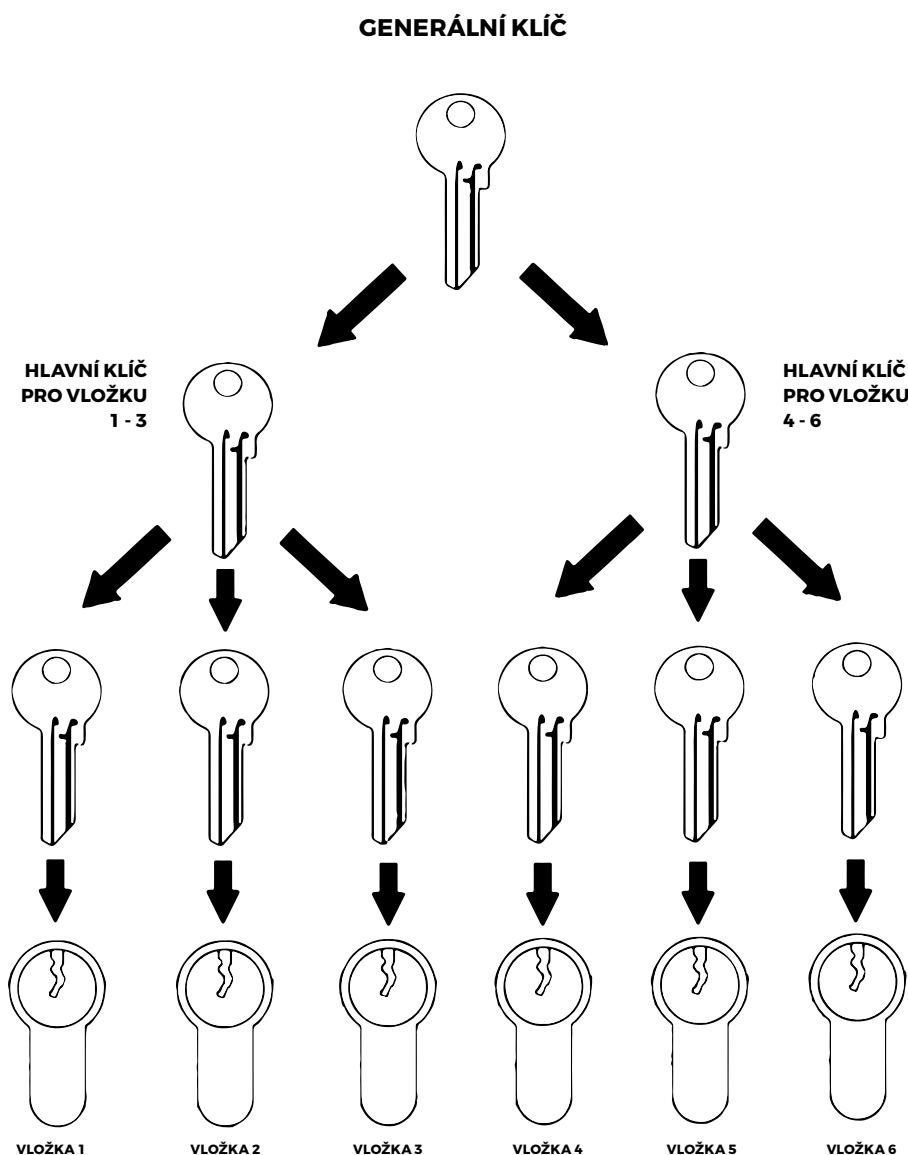

## Společný (sjednocený) uzávěr

Sjednocení vložek je ideální řešení pro rodinné domy nebo firemní prostory, zkrátka tam, kde je mnoho uzamykatelných přístupů. Pro všechny vložky je možné využívat pouze jeden klíč. Při výrobě se použije vzorová vložka, podle které se vyrobí požadovaný počet dalších vložek. Vložky typu EUROSECURE mají v základu 6 klíčů a vložky EUROPLUS mají v základu 3 klíče. Investor **specifikuje typ vložky, rozměr vložek, počet vložek a celkový počet klíčů.**

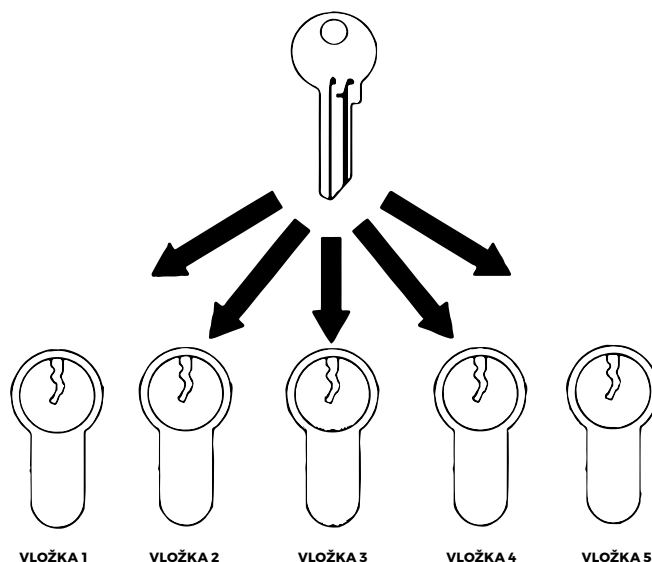

 3

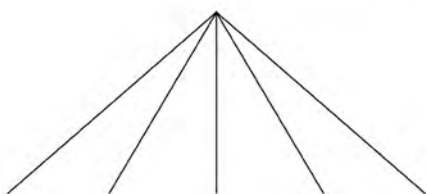

 4

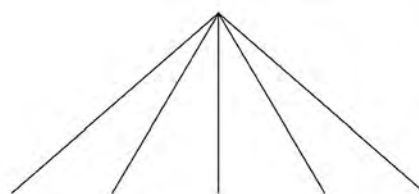



# Piktogramy a číslice nalepovací

Povrch	typ provedení	obj. číslo	CZK	s DPH	EUR	s DPH
IN	Přebalovací pult	CPIBABY	160,0	193,6	6,3	7,6
IN	Dáma	CPIDAMA	160,0	193,6	6,3	7,6
IN	Pán	CPIPAN	160,0	193,6	6,3	7,6
IN	Invalidní	CPIINVAL	160,0	193,6	6,3	7,6
IN	Směr	CPISMER	160,0	193,6	6,3	7,6
IN	Sprcha	CPISPRCH	160,0	193,6	6,3	7,6
IN	Telefon	CPITELEF	160,0	193,6	6,3	7,6
IN	Zákaz kouření	CPINEKUR	160,0	193,6	6,3	7,6
IN	Wifi	CPIWIFI	160,0	193,6	6,3	7,6
IN	WC	CPIWC	160,0	193,6	6,3	7,6
IN	Monitorováno	CPMONIT	160,0	193,6	6,3	7,6
IN	Zákaz telefonování	CPZAKTEL	160,0	193,6	6,3	7,6

Povrch	typ provedení	obj. číslo	CZK	s DPH	EUR	s DPH
IN	.0" 25 mm	C2183E00	45,0	54,5	1,8	2,1
IN	.1" 25 mm	C2183E01	45,0	54,5	1,8	2,1
IN	.2" 25 mm	C2183E02	45,0	54,5	1,8	2,1
IN	.3" 25 mm	C2183E03	45,0	54,5	1,8	2,1
IN	.4" 25 mm	C2183E04	45,0	54,5	1,8	2,1
IN	.5" 25 mm	C2183E05	45,0	54,5	1,8	2,1
IN	.6" 25 mm	C2183E06	45,0	54,5	1,8	2,1
IN	.7" 25 mm	C2183E07	45,0	54,5	1,8	2,1
IN	.8" 25 mm	C2183E08	45,0	54,5	1,8	2,1
IN	.9" 25 mm	C2183E09	45,0	54,5	1,8	2,1
IN	./" 25 mm	C2183E10	45,0	54,5	1,8	2,1



# Číslice a písmena nerez



Povrch	typ provedení	obj. číslo	CZK	s DPH	EUR	s DPH
IN	.0" 150x100x3 mm	C2180E00	165,0	199,7	6,5	7,8
IN	.1" 150x100x3 mm	C2180E01	165,0	199,7	6,5	7,8
IN	.2" 150x100x3 mm	C2180E02	165,0	199,7	6,5	7,8
IN	.3" 150x100x3 mm	C2180E03	165,0	199,7	6,5	7,8
IN	.4" 150x100x3 mm	C2180E04	165,0	199,7	6,5	7,8
IN	.5" 150x100x3 mm	C2180E05	165,0	199,7	6,5	7,8
IN	.6" 150x100x3 mm	C2180E06	165,0	199,7	6,5	7,8
IN	.7" 150x100x3 mm	C2180E07	165,0	199,7	6,5	7,8
IN	.8" 150x100x3 mm	C2180E08	165,0	199,7	6,5	7,8
IN	.9" 150x100x3 mm	C2180E09	165,0	199,7	6,5	7,8
IN	./" 150x100x3 mm	C2180E11	165,0	199,7	6,5	7,8

# Číslice



Povrch	typ provedení	obj. číslo	CZK	s DPH	EUR	s DPH	Povrch	typ provedení	obj. číslo	CZK	s DPH	EUR	s DPH	Povrch	typ provedení	obj. číslo	CZK	s DPH	EUR	s DPH
ONS	.0" 50 mm	C2150N0	50,0	60,5	2,0	2,4	OLV	.0" 50 mm	C2150M0	50,0	60,5	2,0	2,4	OFS	.0" 100 mm	C2160B0	110,0	133,1	4,3	5,2
ONS	.1" 50 mm	C2150N1	50,0	60,5	2,0	2,4	OLV	.1" 50 mm	C2150M1	50,0	60,5	2,0	2,4	OFS	.1" 100 mm	C2160B1	110,0	133,1	4,3	5,2
ONS	.2" 50 mm	C2150N2	50,0	60,5	2,0	2,4	OLV	.2" 50 mm	C2150M2	50,0	60,5	2,0	2,4	OFS	.2" 100 mm	C2160B2	110,0	133,1	4,3	5,2
ONS	.3" 50 mm	C2150N3	50,0	60,5	2,0	2,4	OLV	.3" 50 mm	C2150M3	50,0	60,5	2,0	2,4	OFS	.3" 100 mm	C2160B3	110,0	133,1	4,3	5,2
ONS	.4" 50 mm	C2150N4	50,0	60,5	2,0	2,4	OLV	.4" 50 mm	C2150M4	50,0	60,5	2,0	2,4	OFS	.4" 100 mm	C2160B4	110,0	133,1	4,3	5,2
ONS	.5" 50 mm	C2150N5	50,0	60,5	2,0	2,4	OLV	.5" 50 mm	C2150M5	50,0	60,5	2,0	2,4	OFS	.5" 100 mm	C2160B5	110,0	133,1	4,3	5,2
ONS	.6" 50 mm	C2150N6	50,0	60,5	2,0	2,4	OLV	.6" 50 mm	C2150M6	50,0	60,5	2,0	2,4	OFS	.6" 100 mm	C2160B6	110,0	133,1	4,3	5,2
ONS	.7" 50 mm	C2150N7	50,0	60,5	2,0	2,4	OLV	.7" 50 mm	C2150M7	50,0	60,5	2,0	2,4	OFS	.7" 100 mm	C2160B7	110,0	133,1	4,3	5,2
ONS	.8" 50 mm	C2150N8	50,0	60,5	2,0	2,4	OLV	.8" 50 mm	C2150M8	50,0	60,5	2,0	2,4	OFS	.8" 100 mm	C2160B8	110,0	133,1	4,3	5,2
ONS	.9" 50 mm	C2150N9	50,0	60,5	2,0	2,4	OLV	.9" 50 mm	C2150M9	50,0	60,5	2,0	2,4	OFS	.9" 100 mm	C2160B9	110,0	133,1	4,3	5,2
ONS	./" 50 mm	C2150N/	50,0	60,5	2,0	2,4	OLV	./" 50 mm	C2150M/	42,-	51,-	1,6	2,0	OFS	./" 100 mm	C2160B/	110,0	133,1	4,3	5,2
OFS	.0" 50 mm	C2150B0	50,0	60,5	2,0	2,4	ONS	.0" 100mm	C2160N0	110,0	133,1	4,3	5,2	OLV	.0" 100 mm	C2160M0	110,0	133,1	4,3	5,2
OFS	.1" 50 mm	C2150B1	50,0	60,5	2,0	2,4	ONS	.1" 100 mm	C2160N1	110,0	133,1	4,3	5,2	OLV	.1" 100 mm	C2160M1	110,0	133,1	4,3	5,2
OFS	.2" 50 mm	C2150B2	50,0	60,5	2,0	2,4	ONS	.2" 100 mm	C2160N2	110,0	133,1	4,3	5,2	OLV	.2" 100 mm	C2160M2	110,0	133,1	4,3	5,2
OFS	.3" 50 mm	C2150B3	50,0	60,5	2,0	2,4	ONS	.3" 100 mm	C2160N3	110,0	133,1	4,3	5,2	OLV	.3" 100 mm	C2160M3	110,0	133,1	4,3	5,2
OFS	.4" 50 mm	C2150B4	50,0	60,5	2,0	2,4	ONS	.4" 100 mm	C2160N4	110,0	133,1	4,3	5,2	OLV	.4" 100 mm	C2160M4	110,0	133,1	4,3	5,2
OFS	.5" 50 mm	C2150B5	50,0	60,5	2,0	2,4	ONS	.5" 100 mm	C2160N5	110,0	133,1	4,3	5,2	OLV	.5" 100 mm	C2160M5	110,0	133,1	4,3	5,2
OFS	.6" 50 mm	C2150B6	50,0	60,5	2,0	2,4	ONS	.6" 100mm	C2160N6	110,0	133,1	4,3	5,2	OLV	.6" 100 mm	C2160M6	110,0	133,1	4,3	5,2
OFS	.7" 50 mm	C2150B7	50,0	60,5	2,0	2,4	ONS	.7" 100mm	C2160N7	110,0	133,1	4,3	5,2	OLV	.7" 100 mm	C2160M7	110,0	133,1	4,3	5,2
OFS	.8" 50 mm	C2150B8	50,0	60,5	2,0	2,4	ONS	.8" 100 mm	C2160N8	110,0	133,1	4,3	5,2	OLV	.8" 100 mm	C2160M8	110,0	133,1	4,3	5,2
OFS	.9" 50 mm	C2150B9	50,0	60,5	2,0	2,4	ONS	.9" 100 mm	C2160N9	110,0	133,1	4,3	5,2	OLV	.9" 100 mm	C2160M9	110,0	133,1	4,3	5,2
OFS	./" 50 mm	C2150B/	50,0	60,5	2,0	2,4	ONS	./" 100 mm	C2160N/	110,0	133,1	4,3	5,2	OLV	./" 100 mm	C2160M/	110,0	133,1	4,3	5,2

## Číslice a písmena kovaná

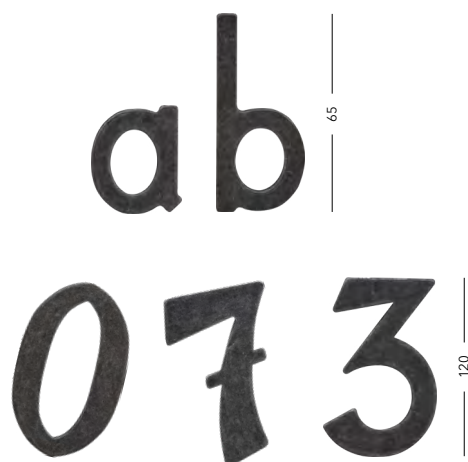

Povrch	typ provedení	obj. číslo	CZK	s DPH	EUR	s DPH
K	„A“ 120 mm	HA00A	380,0	459,8	14,9	18,0
K	„B“ 120 mm	HA00B	380,0	459,8	14,9	18,0
K	„C“ 120 mm	HA00C	380,0	459,8	14,9	18,0
K	„D“ 120 mm	HA00D	380,0	459,8	14,9	18,0
K	„0“ 120 mm	HA000	380,0	459,8	14,9	18,0
K	„1“ 120 mm	HA001	380,0	459,8	14,9	18,0
K	„2“ 120 mm	HA002	380,0	459,8	14,9	18,0
K	„3“ 120 mm	HA003	380,0	459,8	14,9	18,0
K	„4“ 120 mm	HA004	380,0	459,8	14,9	18,0
K	„5“ 120 mm	HA005	380,0	459,8	14,9	18,0
K	„6“ 120 mm	HA006	380,0	459,8	14,9	18,0
K	„7“ 120 mm	HA007	380,0	459,8	14,9	18,0
K	„8“ 120 mm	HA008	380,0	459,8	14,9	18,0
K	„9“ 120 mm	HA009	380,0	459,8	14,9	18,0

## Číslice a písmena nerez černá



Povrch	typ provedení	obj. číslo	CZK	s DPH	EUR	s DPH
ČERNÁ	„A“ 150 mm	C2180B0A	170,0	205,7	6,7	8,1
ČERNÁ	„B“ 150 mm	C2180B0B	170,0	205,7	6,7	8,1
ČERNÁ	„C“ 150 mm	C2180B0C	170,0	205,7	6,7	8,1
ČERNÁ	„D“ 150 mm	C2180B0D	170,0	205,7	6,7	8,1
ČERNÁ	„0“ 150 mm	C2180B00	170,0	205,7	6,7	8,1
ČERNÁ	„1“ 150 mm	C2180B01	170,0	205,7	6,7	8,1
ČERNÁ	„2“ 150 mm	C2180B02	170,0	205,7	6,7	8,1
ČERNÁ	„3“ 150 mm	C2180B03	170,0	205,7	6,7	8,1
ČERNÁ	„4“ 150 mm	C2180B04	170,0	205,7	6,7	8,1
ČERNÁ	„5“ 150 mm	C2180B05	170,0	205,7	6,7	8,1
ČERNÁ	„6“ 150 mm	C2180B06	170,0	205,7	6,7	8,1
ČERNÁ	„7“ 150 mm	C2180B07	170,0	205,7	6,7	8,1
ČERNÁ	„8“ 150 mm	C2180B08	170,0	205,7	6,7	8,1
ČERNÁ	„9“ 150 mm	C2180B09	170,0	205,7	6,7	8,1
ČERNÁ	„/“ 150 mm	C2180B09	170,0	205,7	6,7	8,1

## Klepadla

Povrch	typ provedení	obj. číslo	CZK	s DPH	EUR	s DPH
OLV	Anello Ø 90 mm	BE01102C00	1285,0	1554,9	50,4	61,0
OLV	Anello Ø 110 mm	BE01102B00	1395,0	1688,0	54,7	66,2
K	Tirol Ø 65 mm	HA115006	1325,0	1603,3	52,0	62,9
K	Tirol Ø 85 mm	HA115002	1485,0	1796,9	58,2	70,5
OFS	Lev 150x90 mm	BE0158P00	1275,0	1542,8	50,0	60,5
OLV	Lev 150x90 mm	BE0152P00	1275,0	1542,8	50,0	60,5
OFS	Lev 190x110 mm	BE0158M00	1445,0	1748,5	56,7	68,6
OLV	Lev 190x110 mm	BE0152M00	1445,0	1748,5	56,7	68,6
OFS	Lev 260x150 mm	BE0158G00	1595,0	1930,0	62,5	75,7
OLV	Lev 260x150 mm	BE0152G00	1595,0	1930,0	62,5	75,7



## Stavěč dveří



Povrch	typ provedení	obj. číslo	CZK	s DPH	EUR	s DPH
OC	Stavěč dveří 899	C8991310	115,0	139,2	4,5	5,5
BILÁ	Stavěč dveří 899	C8991320	115,0	139,2	4,5	5,5
OLV	Stavěč dveří 899	C8991330	115,0	139,2	4,5	5,5
Hnědá	Stavěč dveří 899	C8991340	115,0	139,2	4,5	5,5
ONS	Stavěč dveří 899	C8991350	115,0	139,2	4,5	5,5

Povrch	typ provedení	obj. číslo	CZK	s DPH	EUR	s DPH
OLV	Stavěč dveří 898S	C8981310	125,0	151,3	4,9	5,9
Hnědá	Stavěč dveří 898S	C8981310	125,0	151,3	4,9	5,9
ONS	Stavěč dveří 898S	C8981310	125,0	151,3	4,9	5,9

Povrch	typ provedení	obj. číslo	CZK	s DPH	EUR	s DPH
OLV	Stavěč dveří 898L	C8982830	140,0	169,4	5,5	6,6
Hnědá	Stavěč dveří 898L	C8982840	140,0	169,4	5,5	6,6
ONS	Stavěč dveří 898L	C8982850	140,0	169,4	5,5	6,6

## Zarážka dveří



Povrch	typ provedení	obj. číslo	CZK	s DPH	EUR	s DPH
OCS	Zarážka dveří 1004	C10049X00	90,0	108,9	3,5	4,3
OC	Zarážka dveří 1004	C10045X00	90,0	108,9	3,5	4,3
ONS	Zarážka dveří 1004	C10046X00	90,0	108,9	3,5	4,3
OFS	Zarážka dveří 1004	C10048X00	90,0	108,9	3,5	4,3
OLV	Zarážka dveří 1004	C10042X00	90,0	108,9	3,5	4,3

Povrch	typ provedení	obj. číslo	CZK	s DPH	EUR	s DPH
IN	Zarážka dveří 2264	C2264EX00	120,0	145,2	4,7	5,7
OCS	Zarážka dveří 2264	C22649X00	120,0	145,2	4,7	5,7
OC	Zarážka dveří 2264	C22645X00	120,0	145,2	4,7	5,7
ONS	Zarážka dveří 2264	C22646X00	120,0	145,2	4,7	5,7
OFS	Zarážka dveří 2264	C22648X00	120,0	145,2	4,7	5,7
OLV	Zarážka dveří 2264	C22642X00	120,0	145,2	4,7	5,7

Povrch	typ provedení	obj. číslo	CZK	s DPH	EUR	s DPH
IN	Zarážka dveří Ø 25	C1001EX00	120,0	145,2	4,7	5,7
OCS	Zarážka dveří Ø 32	C10019X00	175,0	211,8	6,9	8,3
OC	Zarážka dveří Ø 32	C10015X00	175,0	211,8	6,9	8,3
ONS	Zarážka dveří Ø 32	C10016X00	175,0	211,8	6,9	8,3
OFS	Zarážka dveří Ø 32	C10018X00	175,0	211,8	6,9	8,3
OLV	Zarážka dveří Ø 32	C10012X00	175,0	211,8	6,9	8,3

Povrch	typ provedení	obj. číslo	CZK	s DPH	EUR	s DPH
IN	Zarážka puk	RIZARPUK	290,0	350,9	11,4	13,8

## Zarážka okenní

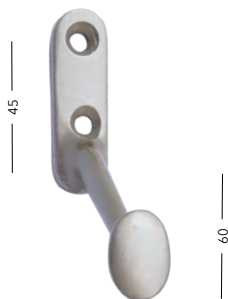

Povrch	typ provedení	obj. číslo	CZK	s DPH	EUR	s DPH
OCS	Okenní zarážka	81990090	190,0	229,9	7,5	9,0
OC	Okenní zarážka	81990050	190,0	229,9	7,5	9,0
ONS	Okenní zarážka	81990060	190,0	229,9	7,5	9,0
OLV	Okenní zarážka	81990010	190,0	229,9	7,5	9,0
OFS	Okenní zarážka	81990030	190,0	229,9	7,5	9,0
BILÁ	Okenní zarážka	81990070	190,0	229,9	7,5	9,0
OV	Okenní zarážka	81990040	190,0	229,9	7,5	9,0

## Přídavné řetízky a kukátka

Povrch	typ provedení	obj. číslo	CZK	s DPH	EUR	s DPH
OC	Zástrč 620GA	R620GA5	260,0	314,6	10,2	12,3
OFS	Zástrč 620GA	R620GA7	260,0	314,6	10,2	12,3
OLV	Zástrč 620GA	R620GA2	260,0	314,6	10,2	12,3
OC	Zarážka okenní 603FE	RJ603FE5	300,0	363,0	11,8	14,2
OFS	Zarážka okenní 603FE	RJ603FE7	300,0	363,0	11,8	14,2
OLV	Zarážka okenní 603FE	RJ603FE2	300,0	363,0	11,8	14,2
OC	Řetízek 636CN	RJ636CN5	190,0	229,9	7,5	9,0
OLV	Řetízek 636CN	RJ636CN2	190,0	229,9	7,5	9,0
OC	Řetízek 633CN	RJ633CN5	180,0	217,8	7,1	8,5
OLV	Řetízek 633CN	RJ633CN2	180,0	217,8	7,1	8,5
ONS	Řetízek	CRETO6	180,0	217,8	7,1	8,5
OFS	Řetízek	CRETO8	180,0	217,8	7,1	8,5
OLV	Řetízek	CRETO2	180,0	217,8	7,1	8,5
OC	Kuk 3 14/35-60 mm	A4231	190,0	229,9	7,5	9,0
OCS	Kuk 3 14/35-60 mm	A42316	245,0	296,5	9,6	11,6
OLV	Kuk 3 14/35-60 mm	A1237	200,0	242,0	7,8	9,5
OC	Kuk 5 16/60-85 mm	A4233	315,0	381,2	12,4	14,9
OCS	Kuk 5 16/60-85 mm	A42336	340,0	411,4	13,3	16,1
OLV	Kuk 5 16/60-85 mm	A1482	340,0	411,4	13,3	16,1
černá	Kuk 3 14/25-42 mm	A9968	190,0	229,9	7,5	9,0
černá	Kuk 5 16/60-85 mm	A9971	350,0	423,5	13,7	16,6

Řetízek 636CN



Řetízek



Zástrč 620GA



Zarážka okenní 603FE



Řetízek 633CN



Kukátko



14,16

35-60

60-85

Kukátko 3 14/25-42 mm



14,16

35-60

60-85

Kukátko 5 16/60-85 mm



14,16

35-60

60-85

Povrch	typ provedení	obj. číslo	CZK	s DPH	EUR	s DPH
OLV	KUKÁTKO DIGITÁLNÍ PR14/40-70 mm	A21376	2800,0	3388,0	109,0	132,8
OC	KUKÁTKO DIGITÁLNÍ PR14/40-70 mm	A21377	2800,0	3388,0	109,0	132,8

obj. číslo	CZK	s DPH	EUR	s DPH
A21376	2800,0	3388,0	109,0	132,8
A21377	2800,0	3388,0	109,0	132,8



## Dveřní sklapka

Povrch	typ provedení	obj. číslo	CZK	s DPH	EUR	s DPH
OLV	Sklapka komplet A	M06042X0A	200,0	242,0	7,8	9,5

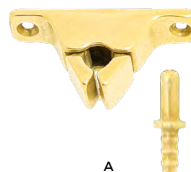

A

## Držák zábradlí

L8758

C2263 31

M099



Povrch	typ provedení	obj. číslo	CZK	s DPH	EUR	s DPH
IN	L8758	CSL8758	700,-	847,-	27,5	32,9
IN	C2263 31	C2263EX31	280,-	339,-	11,0	13,2
OFS	M099	M09908X00	590,-	714,-	23,1	27,8
OLV	M099	M09902X00	590,-	714,-	23,1	27,8

## Drobný materiál

Červík

Poj. kroužek

Pružina



Rohatka dvoustr.

Rohatka jednostr.



Vrut



Přechodka

Šroub průchozí



Tyčka



Nový kod	Nový název	CZK	s DPH	EUR	s DPH
SMK0101	Cervik _5mm (2Ks)	20,0	24,2	0,8	0,9
SMK0102	Cervik _6mm (2Ks)	20,0	24,2	0,8	0,9
SMK0103	Cervik D.3mm (2Ks)	20,0	24,2	0,8	0,9
SMK0201	Poj.krouzek D.15	5,0	6,0	0,4	0,5
SMK0301	Prechodka 4/6mm - (Plast)	12,0	14,0	0,5	0,6
SMK0302	Prechodka 6/7mm	20,0	24,2	0,8	0,9
SMK0303	Prechodka 6/8mm	25,0	30,3	1,0	1,2
SMK0304	Prechodka 7/8mm	25,0	30,3	1,0	1,2
SMK0306	Prechodka 8/8.5mm	25,0	30,3	1,0	1,2
SMK0307	Prechodka 8/9mm	25,0	30,3	1,0	1,2
SMK0305	Prechodka 8/10mm	25,0	30,3	1,0	1,2
SMK0401	Pružina silnejsi	15,0	18,2	0,6	0,7
SMK0402	Pružina slabši	15,0	18,2	0,6	0,7
SMK0501	Rohatka dvoustr. 1.2mm	15,0	18,2	0,6	0,7
SMK0502	Rohatka jednostr.1.0mm	15,0	18,2	0,6	0,7
SMK0601	Sroub Pruchozí - rozeta - matka M4	6,0	8,0	0,3	0,3
SMK0602	Sroub Pruchozí - rozeta M4	9,0	10,0	0,4	0,4
SMK0701	Tyčka 8X8x70mm se závitem	35,0	42,4	1,4	1,7
SMK0702	Tyčka 8X8x78mm se závitem	40,0	48,4	1,6	1,9
SMK0703	Tyčka 8X8x95mm	25,0	30,3	1,0	1,2
SMK0704	Tyčka 8X8x10mm	25,0	30,3	1,0	1,2
SMK0705	Tyčka 8X8x110mm	25,0	30,3	1,0	1,2
SMK0706	Tyčka 8X8x140mm	25,0	30,3	1,0	1,2
SMK0707	Tyčka 8X8x150mm	25,0	30,3	1,0	1,2
SMK0801	Vrut 3,5X25mm Olv (4Ks)	5,0	6,1	0,2	0,2
SMK0802	Vrut 3,5X25mm Of (4Ks)	5,0	6,1	0,2	0,2
SMK0803	Vrut 3,5X25mm Ocn (4Ks)	5,0	6,1	0,2	0,2
SMKSAD01	Spojovací mat. - štítové kov. Olv	25,0	30,3	1,0	1,2
SMKSAD02	Spojovací mat. - štítové kov. Of	25,0	30,3	1,0	1,2
SMKSAD03	Spojovací mat. - štítové kov. univ.	25,0	30,3	1,0	1,2
SMKSAD04	Spojovací mat. - štítové kov. - nerez	25,0	30,3	1,0	1,2
SMKSAD05	Spojovací mat. - rozetové kování	25,0	30,3	1,0	1,2
SMKSAD06	Spojovací mat. - ozetové kování M3	25,0	30,3	1,0	1,2
SMKSAD07	Spojovací mat. - ozetové kování plast	25,0	30,3	1,0	1,2
AB89160	Čtyřhran Assa Abloy 8X9X160	520,-	629,-	20	24

# Krbové nářadí

Povrch	typ provedení	obj. číslo	CZK	s DPH	EUR	s DPH
černá	Inox	KRBINOX	1275,0	1542,8	50,0	60,5
černá	Rustik	KRBRUSTIK	1275,0	1542,8	50,0	60,5
černá	Wood	KRBWOOD	860,0	1040,6	33,7	40,8

Inox



620

Rustik



620

Wood



640

## Cobra dětem Kiddy

cena za kus

Povrch	typ provedení	obj. číslo	CZK	s DPH	EUR	s DPH
Žlutá	BB 72 žlutá	B222ZL164	280,0	338,8	11,0	13,3
Zelená	BB 72 zelená	B222Z164	280,0	338,8	11,0	13,3

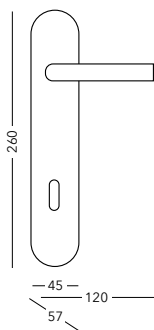

Do vyprodání zásob

## Dětský věšák

Do vyprodání zásob

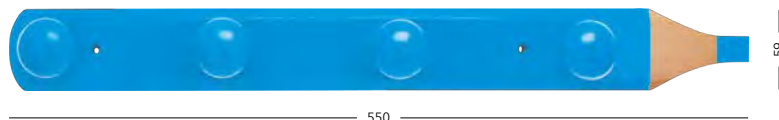

cena za kus

Povrch	typ provedení	obj. číslo	CZK	s DPH	EUR	s DPH
Červená	Červený 4 háčky	B223C00	310,0	375,1	12,2	14,7
Žlutá	Žlutý 4 háčky	B223ZL00	310,0	375,1	12,2	14,7
Zelená	Zelený 4 háčky	B223Z00	310,0	375,1	12,2	14,7
Modrá	Modrý 4 háčky	B223M00	310,0	375,1	12,2	14,7

# Panikové kování Dorma



## PHA 2000

S řadou PHA 2000 a s univerzálně použitelným vnějším kováním PHT máte k dispozici program, který lze využít jak u úzkých systémů profilových dveří, tak také u plných dveří. Systém je modulární, snadno nastavitelný pro různé šířky a výšky dveří. Uzávěr panikových dveří je přezkoušen podle EN 1125.

## Exit Pad

Kování řady DORMA Exit Pad jsou vysoce kvalitní uzávěry pro nouzové východy dveří v únikových cestách a lze je kombinovat s komponenty řad PHA 2000. Používají se v budovách bez pohybu veřejnosti. Očekává se, že lidé využívající budovu znají příslušné východy a jejich vybavení, aby v nouzové situaci nedošlo k panice. Produkty Exit Pad jsou přezkoušeny a certifikovány podle EN 179.

## Výhody

- Snadná montáž (levé i pravé dveře)
- Jednoduché nastavení pro různé šířky a výšky dveří
- Univerzální použití externího kování s klikou nebo DORMA
- Rozvorové tyče s kovovými kryty
- Jednoduchá obsluha a vynikající kvalita zajišťuje vysokou životnost
- Balení vše v jednom



## Jak vybrat komponenty?

### Komponenty u jednokřídlých dveří

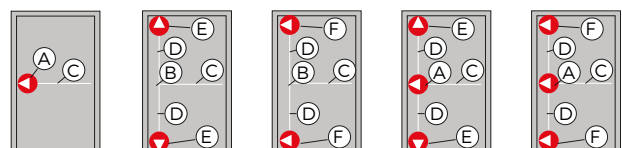

A, C lze nahradit G

B, C lze nahradit H

B, C lze nahradit H

### Komponenty u dvoukřídlých dveří

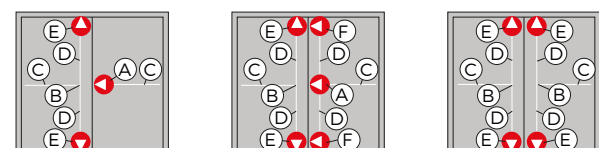

B, C lze nahradit H  
A, C lze nahradit G

B, C lze nahradit H  
B, C lze nahradit

	A	B	C	D	E
	PHA 2101 *	PHA 2201	PHA 2104	PHX 04 *	PHX 03
OBJ. KÓD	HBDPHA2101	HBDPHA2201	HBDPHA2104	HBDPHX04	HBDPHX03
CENA	3 190,00	2 655,00	440,00	1 155,00	2 695,00
NÁZEV	1-bodové zamykání	2-bodové zamykání	paniková tyč	sada rozvorových tyčí	horní a dolní zamykání

	F	G	H	CH	I
	PHX 06 *	EXIT PAD *	EXIT PAD 2P *	PHT 01 *	PHT 06 *
OBJ. KÓD	HBDPHX06	HBDEXITPAD	HBDEXITPAD2	HBDPHT01	HBDPHT06
CENA	6 210,00	3 190,00	6 551,00	1 915,00	1 775,00
NÁZEV	horní a dolní zamykání s horizontální střílkou	1-bodové zamykání	2-bodové zamykání	vnější kování s klikou	vnější kování s pevnou koulí

\* U JEDNOKŘÍDLÝCH A DVOUKŘÍDLÝCH DVEŘÍ LZE POUŽÍT KOVÁNÍ S KLIKOU (CH) A PEVNOU KOULÍ (I)

Sada PHA 2000 - 1/1 pro jednokřídlé dveře, 1-bodové uzamykání	<b>CZK</b>	s DPH	<b>EUR</b>	s DPH
Panikové kování 1-bodové 2101	3605,0	4362,1	141,4	171,1
Sada PHA 2000 - 1/3 pro jednokřídlé dveře, 3-bodové uzamykání				
Panikové kování 3-bodové 2101	3605,0	4362,1	141,4	171,1
Horní a spodní stříelky černé PHX03	3045,0	3684,5	119,4	144,5
Rozvorové táhla stříbrné PHX04	1305,0	1579,1	51,2	61,9
Sada PHA 2000 - 2/3 pro dvoukřídlé dveře, 3-bodové uzamykání				
Panikové kování 1-bodové 2101	3605,0	4362,1	141,4	171,1
Panikové kování 2-bodové 2201	2995,0	3624,0	117,5	142,1
Horní a spodní stříelky černé PHX03	3045,0	3684,5	119,4	144,5
Rozvorové táhla stříbrné PHX04	1305,0	1579,1	51,2	61,9
Sada PUSHPAD 1/1 pro jednokřídlé dveře, 1-bodové uzamykání				
Panikové kování EXITPAD, 1-bodové	3605,0	4362,1	141,4	171,1
Sada PUSHPAD 1/3 pro jednokřídlé dveře, 3-bodové uzamykání				
Panikové kování EXITPAD, 3-bodové	3605,0	4362,1	141,4	171,1
Horní a spodní stříelky černé	3035,0	3672,4	119,0	144,0
Rozvorové táhla stříbrné	1305,0	1579,1	51,2	61,9
Madla pro panikové kování (nejsou součástí nabídky a je nutno je uvádět zvlášť)				
Ocelové madlo stříbrné, 1000 mm PHA2104	495,0	599,0	19,4	23,5
Vnější kliky k panikovému kování (nejsou součástí nabídky a je nutno je uvádět zvlášť)				
Stříbrný štít pro uzamykatelnou kliku pro cyl. půvložku PHT01	2165,0	2619,7	84,9	102,7
Stříbrný štít s koulí pro cyl. půvložku PHT06	2010,0	2432,1	78,8	95,4





# Rozety

**5 3**

Bez otvoru



Ø 55

BB



Ø 52/55

PZ



Ø 52/55

WC



Ø 52/55



Ø 52/55

BB/ PZ ovál

70



30

BB/PZ hranatý ovál

60



30



55



55



55

WC set



55



55



Sortiment rozetového kování na masivní základně nabízíme na šroubovacích rozetách.  
Sortiment rozetového kování Economy nabízíme na narážecích rozetách pro snadnou a rychlou montáž.

\*Záruka 3 roky na povrch OCS, cena za kus (WC cena za pár)

\*Záruka 5 roky na povrch IN, cena za kus (WC cena za pár)

	Povrch	typ provedení	CZK	s DPH	EUR	s DPH
🔑	IN	BB/PZ	160,0	193,6	6,3	7,6
🔑	IN	WC set	405,0	490,1	15,9	19,2
🔑	IN	Ovál BB/PZ	160,0	193,6	6,3	7,6
🔑	IN	Ovál WC	405,0	490,1	15,9	19,2
🔑	OCS	BB/PZ	160,0	193,6	6,3	7,6
🔑	OCS	WC set	405,0	490,1	15,9	19,2
🔑	OC	BB/PZ	160,0	193,6	6,3	7,6
🔑	OC	WC set	405,0	490,1	15,9	19,2

	Povrch	typ provedení	CZK	s DPH	EUR	s DPH
🔑	ONS	BB/PZ	160,0	193,6	6,3	7,6
🔑	ONS	WC set	405,0	490,1	15,9	19,2
🔑	OCN	BB/PZ	160,0	193,6	6,3	7,6
🔑	OCN	WC set	405,0	490,1	15,9	19,2
🔑	OF	BB/PZ	160,0	193,6	6,3	7,6
🔑	OF	WC set	405,0	490,1	15,9	19,2
🔑	OLV	BB/PZ	160,0	193,6	6,3	7,6
🔑	OLV	WC set	405,0	490,1	15,9	19,2

	Povrch	typ provedení	CZK	s DPH	EUR	s DPH
🔑	IN	BB/PZ economy	160,0	193,6	6,3	7,6
🔑	IN	WC set economy	405,0	490,1	15,9	19,2
🔑	IN	BB/PZ hr. ovál	160,0	193,6	6,3	7,6
🔑	IN	Bez otvoru hr. ovál	150,0	181,5	5,9	7,1

## Vrtací šablona

🔑	<b>CZK</b>	bez DPH	s DPH
	cena	2190,-	2650,-
🔑	<b>EUR</b>	bez DPH	s DPH
	cena	85,8	103,9



šablona na panty

## Vrtací šablona na panty

Rozměry	CZK	s DPH	EUR	s DPH
190 (030.055.300) 13 PVC	875,0	1058,8	34,3	41,5
190 (030.055.300) 14 PVC	905,0	1095,1	35,5	42,9
320 16 PVC	950,0	1149,5	37,3	45,1
495 14/16 PVC	995,0	1204,0	39,0	47,2
190 (180.030.055.300) 16 PVC	995,0	1204,0	39,0	47,2
320 18 PVC	1135,0	1373,4	44,5	53,9
495 20 PVC	1135,0	1373,4	44,5	53,9
320 20 PVC	1135,0	1373,4	44,5	53,9

## Těsnící prahová lišta s gumou nebo kartáčkem

Povrch	typ provedení	obj. číslo	CZK	s DPH	EUR	s DPH
Bílá	Guma 1000 mm	PC-1250B	270,0	326,7	10,6	12,8
Hnědá	Guma 1000 mm	PC-1250H	270,0	326,7	10,6	12,8
Bílá	Kartáč 1000 mm	PC-1251B	270,0	326,7	10,6	12,8
Hnědá	Kartáč 1000 mm	PC-1251H	270,0	326,7	10,6	12,8



## Mechanická výsuvná prahová lišta

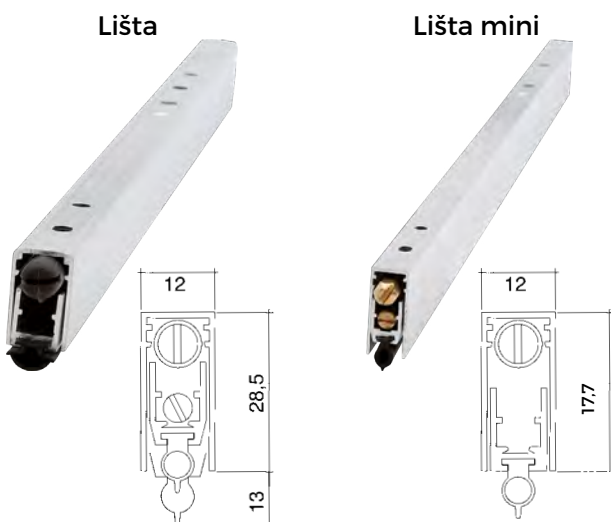

Název	obj. číslo	CZK	s DPH	EUR	s DPH
Lišta mini 330 mm	PC-420M033	390,0	471,9	15,3	18,5
Lišta mini 430 mm	PC-420M043	400,0	484,0	15,7	19,0
Lišta mini 630 mm	PC-420M063	420,0	508,2	16,5	19,9
Lišta mini 830 mm	PC-420M083	470,0	568,7	18,4	22,3
Lišta mini 930 mm	PC-420M093	480,0	580,8	18,8	22,8
Lišta mini 1030 mm	PC-420M103	490,0	592,9	19,2	23,3
Lišta mini 1230 mm	PC-420M123	530,0	641,3	20,8	25,1
Lišta mini 1330 mm	PC-420M133	530,0	641,3	20,8	25,1
Lišta 430 mm	PC-T017043	580,0	701,8	22,7	27,5
Lišta 530 mm	PC-T017053	590,0	713,9	23,1	28,0
Lišta 630 mm	PC-T017063	620,0	750,2	24,3	29,4
Lišta 730 mm	PC-T017073	630,0	762,3	24,7	29,9
Lišta 830 mm	PC-T017083	660,0	798,6	25,9	31,3
Lišta 930 mm	PC-T017093	660,0	798,6	25,9	31,3
Lišta 1030 mm	PC-T017103	690,0	834,9	27,1	32,7
Lišta 1130 mm	PC-T017113	690,0	834,9	27,1	32,7
Lišta 1230 mm	PC-T017123	730,0	883,3	28,6	34,6
Lišta 1330 mm	PC-T017133	750,0	907,5	29,4	35,6

## Koordinátor zavírání

Povrch	typ provedení	CZK	s DPH	EUR	s DPH
bílá	Koordinátor zavírání dveří	1820,-	2202,-	77,4	92,9
stříbrná	Koordinátor zavírání dveří	1820,-	2202,-	77,4	92,9

Koordinátor



## Pružinový zavírač

Povrch	typ provedení	obj. číslo	CZK	s DPH	EUR	s DPH
F1	Pružinový zavírač	56-01	1000,0	1210,0	39,2	47,5

Pružinový zavírač



## Cobra samozavírače

Povrch	typ provedení	CZK	s DPH	EUR	s DPH
stříbrná	RZ 202	590,0	713,9	23,1	28,0
stříbrná	RZ 903	1140,0	1379,4	44,7	54,1

RZ 202 Šířka dveří max 850 mm, váha dveří max 45 kg, síla zavírání č. 2



RZ 903



## Dveřní zavírač

**GEZE**

Povrch	typ a síla zavírání	obj. číslo	CZK	s DPH	EUR	s DPH
Bílá	TS4000 1-6/5-7	TS4000B	3580,0	4331,8	140,4	169,9
Hnědá	TS4000 1-6/5-7	TS4000H	3580,0	4331,8	140,4	169,9
Stříbrná	TS4000 1-6/5-7	TS4000S	3580,0	4331,8	140,4	169,9
Bílá	TS4000 + aretace	TS4000BAN	4625,0	5596,3	181,4	219,5
Hnědá	TS4000 + aretace	TS4000HAN	4625,0	5596,3	181,4	219,5
Stříbrná	TS4000 + aretace	TS4000SAN	4625,0	5596,3	181,4	219,5
Bílá	TS5000 5-6	TS5000B	7015,0	8488,2	275,1	332,9
Hnědá	TS5000 5-6	TS5000H	7015,0	8488,2	275,1	332,9
Stříbrná	TS5000 5-6	TS5000S	7015,0	8488,2	275,1	332,9
Bílá	TS5000 + aretace	TS5000BAN	7915,0	9577,2	310,4	375,6
Hnědá	TS5000 + aretace	TS5000HAN	7915,0	9577,2	310,4	375,6
Stříbrná	TS5000 + aretace	TS5000SAN	7915,0	9577,2	310,4	375,6

Od modelu TS1000 použitelné pro požární a kouřotěsné dveře.  
Modely TS2000 a TS4000 je možno za příplatek dodat s vypínací aretací.

Povrch	typ a síla zavírání	obj. číslo	CZK	s DPH	EUR	s DPH
Bílá	TS1000 2/3	TS1000B	1050,0	1270,5	41,2	49,8
Hnědá	TS1000 2/3	TS1000H	1050,0	1270,5	41,2	49,8
Stříbrná	TS1000 2/3	TS1000S	1050,0	1270,5	41,2	49,8
Bílá	TS1000 + aretace	TS1000BAN	1935,0	2341,4	75,9	91,8
Hnědá	TS1000 + aretace	TS1000HAN	1935,0	2341,4	75,9	91,8
Stříbrná	TS1000 + aretace	TS1000SAN	1935,0	2341,4	75,9	91,8
Bílá	TS1500 3/4	TS1500B	1725,0	2087,3	67,6	81,9
Hnědá	TS1500 3/4	TS1500H	1725,0	2087,3	67,6	81,9
Stříbrná	TS1500 3/4	TS1500S	1610,0	1948,1	63,1	76,4
Bílá	TS1500 + aretace	TS1500BAN	2345,0	2837,5	92,0	111,3
Hnědá	TS1500 + aretace	TS1500HAN	2345,0	2837,5	92,0	111,3
Stříbrná	TS1500 + aretace	TS1500SAN	2345,0	2837,5	92,0	111,3
Bílá	TS2000 2/4/5	TS2000B	1475,0	1784,8	57,8	70,0
Hnědá	TS2000 2/4/5	TS2000H	1475,0	1784,8	57,8	70,0
Stříbrná	TS2000 2/4/5	TS2000S	1475,0	1784,8	57,8	70,0
Černá	TS2000 2/4/5	TS2000C	1590,0	1924,-	61,4	73,7
Bílá	TS2000 + aretace	TS2000BAN	2865,0	3466,7	112,4	135,9
Hnědá	TS2000 + aretace	TS2000HAN	2865,0	3466,7	112,4	135,9
Stříbrná	TS2000 + aretace	TS2000SAN	2865,0	3466,7	112,4	135,9
Černá	TS2000 + aretace	TS2000CAN	2890,0	3497,-	111,6	133,9
Bílá	TS3000 1-4	TS3000B	4080,0	4936,8	160,0	193,6
Hnědá	TS3000 1-4	TS3000H	4080,0	4936,8	160,0	193,6
Stříbrná	TS3000 1-4	TS3000S	4080,0	4936,8	160,0	193,6
Černá	TS3000 1-4	TS3000C	4080,0	4936,8	160,0	193,6
Bílá	TS3000 + aretace	TS3000BAN	5025,0	6080,3	197,1	238,4
Hnědá	TS3000 + aretace	TS3000HAN	5025,0	6080,3	197,1	238,4
Stříbrná	TS3000 + aretace	TS3000SAN	5025,0	6080,3	197,1	238,4
Černá	TS3000 + aretace	TS3000CAN	5350,0	6474,-	206,6	247,9

## Samozavírače

Povrch	název	obj. číslo	CZK	s DPH	EUR	s DPH
Černá	TS14 dveřní zavírač s ramínkem	METS14RB	1455,0	1761,0	57	68,4
Stříbrná	TS14 dveřní zavírač s ramínkem	METS14RS	1455,0	1761,0	57	68,4
Stříbrná	TS20 dveřní zavírač s ramínkem	METS20R	1855,0	2245,0	72	86,4
Černá	TS20 dveřní zavírač s ramínkem	METS20RB	1855,0	2245,0	72	86,4
Černá	TS41 dveřní zavírač s kluznou lištou - aretace	METS41KLAB	4645,0	5620,0	182	218,4
Stříbrná	TS41 dveřní zavírač s kluznou lištou - aretace	METS41KLAS	4645,0	5620,0	182	218,4
Černá	TS41 dveřní zavírač s kluznou lištou	METS41KLB	3620,0	4380,0	140	168
Stříbrná	TS41 dveřní zavírač s kluznou lištou - aretace	METS41KLS	3620,0	4380,0	140	168



Povrch	název	obj. číslo	CZK	s DPH	EUR	s DPH
Stříbrná	TS14 TS14	TS14	990,0	1198,0	42,1	50,6
IN	TS20 TS20	TS20	1855,0	2245,0	72	86,4
IN	TS41 TS41	TS41	4645,0	5620,0	182	218,4

## Samozavírač DC 120 / DC 140 DC 300 stříbrný

**ASSA ABLOY**

Povrch	typ provedení	CZK	s DPH	EUR	s DPH
stříbrná	Samozavírač DC 120 s ramínkem	1470,0	1779,0	57,6	69,8
stříbrná	Samozavírač DC 140 s ramínkem	1660,0	2009,0	65,1	78,8
stříbrná	Samozavírač DC 140 s kluznou lištou	1518,0	1837,0	69,1	83
stříbrná	Samozavírač DC 140 s aretací	3315,0	4011,0	141,1	169,3
Černá	Samozavírač DC 140 s kluznou lištou	1950,0	2360,0	75,3	90,4

Povrch	typ provedení	CZK	s DPH	EUR	s DPH
stříbrná	Samozavírač DC 300 s ramínkem	3560,0	4307,6	139,6	168,9
stříbrná	Samozavírač DC 300 s aretačním ramínkem	4140,0	5009,4	162,4	196,4
stříbrná	Samozavírač DC 300 s kluznou lištou	3660,0	4428,6	143,5	173,7
Černá	Samozavírač DC 300 s kluznou lištou	3400,0	4114,-	144,7	173,6

DC 120



Šířka dveří max 1100 mm,  
váha dveří max 80 kg,  
síla zavírání č. 2, 3, 4

DC 140



Šířka dveří max 1250 mm,  
váha dveří max 80 kg,  
síla zavírání č. 2, 3, 4

DC 300



## Větrací mřížky

Povrch	typ provedení	obj. číslo	CZK	s DPH	EUR	s DPH
Bílá	60x400 mm	CM0600400B	110,0	133,1	4,3	5,2
Hnědá	60x400 mm	CM0600400H	110,0	133,1	4,3	5,2
Stříbrná	60x400 mm	CM0600400S	110,0	133,1	4,3	5,2
Bílá	60x500 mm	CM0600500B	120,0	145,2	4,7	5,7
Hnědá	60x500 mm	CM0600500H	120,0	145,2	4,7	5,7
Stříbrná	60x500 mm	CM0600500S	120,0	145,2	4,7	5,7
Bílá	60x600 mm	CM0600600B	150,0	181,5	5,9	7,1
Hnědá	60x600 mm	CM0600600H	150,0	181,5	5,9	7,1
Stříbrná	60x600 mm	CM0600600S	150,0	181,5	5,9	7,1
Bílá	60x800 mm	CM0600800B	195,0	236,0	7,6	9,3
Hnědá	60x800 mm	CM0600800H	195,0	236,0	7,6	9,3
Stříbrná	60x800 mm	CM0600800S	195,0	236,0	7,6	9,3
Bílá	60x1000 mm	CM0601000B	225,0	272,3	8,8	10,7
Hnědá	60x1000 mm	CM0601000H	225,0	272,3	8,8	10,7
Stříbrná	60x1000 mm	CM0601000S	225,0	272,3	8,8	10,7
Bílá	80x400 mm	CM0800400B	120,0	145,2	4,7	5,7
Hnědá	80x400 mm	CM0800400H	120,0	145,2	4,7	5,7
Stříbrná	80x400 mm	CM0800400S	120,0	145,2	4,7	5,7
Bílá	80x500 mm	CM0800500B	160,0	193,6	6,3	7,6
Hnědá	80x500 mm	CM0800500H	160,0	193,6	6,3	7,6
Stříbrná	80x500 mm	CM0800500S	160,0	193,6	6,3	7,6
Bílá	80x600 mm	CM0800600B	180,0	217,8	7,1	8,5
Hnědá	80x600 mm	CM0800600H	180,0	217,8	7,1	8,5
Stříbrná	80x600 mm	CM0800600S	180,0	217,8	7,1	8,5
Bílá	80x800 mm	CM0800800B	235,0	284,4	9,2	11,2
Hnědá	80x800 mm	CM0800800H	235,0	284,4	9,2	11,2
Stříbrná	80x800 mm	CM0800800S	235,0	284,4	9,2	11,2
Bílá	80x1000 mm	CM0801000B	300,0	363,0	11,8	14,2
Hnědá	80x1000 mm	CM0801000H	300,0	363,0	11,8	14,2
Stříbrná	80x1000 mm	CM0801000S	300,0	363,0	11,8	14,2
Bílá	100x400 mm	CM1000400B	140,0	169,4	5,5	6,6
Hnědá	100x400 mm	CM1000400H	140,0	169,4	5,5	6,6
Stříbrná	100x400 mm	CM1000400S	140,0	169,4	5,5	6,6
Bílá	100x500 mm	CM1000500B	195,0	236,0	7,6	9,3
Hnědá	100x500 mm	CM1000500H	195,0	236,0	7,6	9,3
Stříbrná	100x500 mm	CM1000500S	195,0	236,0	7,6	9,3
Bílá	100x600 mm	CM1000600B	245,0	296,5	9,6	11,6
Hnědá	100x600 mm	CM1000600H	245,0	296,5	9,6	11,6
Stříbrná	100x600 mm	CM1000600S	245,0	296,5	9,6	11,6
Bílá	100x800 mm	CM1000800B	300,0	363,0	11,8	14,2
Hnědá	100x800 mm	CM1000800H	300,0	363,0	11,8	14,2
Stříbrná	100x800 mm	CM1000800S	300,0	363,0	11,8	14,2
Bílá	100x1000 mm	CM1001000B	365,0	441,7	14,3	17,3
Hnědá	100x1000 mm	CM1001000H	340,0	411,4	13,3	16,1
Stříbrná	100x1000 mm	CM1001000S	340,0	411,4	13,3	16,1

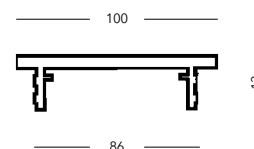
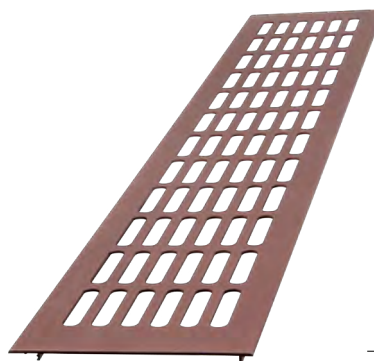
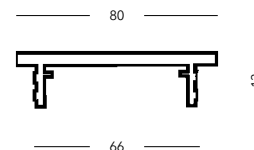
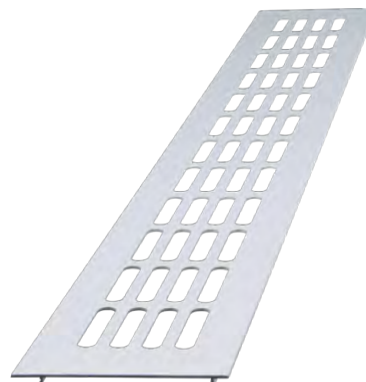

## Vhozy na dopisy

Povrch	typ provedení	obj. číslo	CZK	s DPH	EUR	s DPH
ONS	Vittoria 255x74 mm	FB0255766	880,0	1064,8	34,5	41,8
OFS	Vittoria 255x74 mm	FB0255768	880,0	1064,8	34,5	41,8
OLV	Vittoria 255x74 mm	FB0255762	720,0	871,2	28,2	34,2
K	Bernard 285x85 mm	HA121009	1130,0	1367,3	44,3	53,6
K	Rustikal 285x85 mm	HA121007	1130,0	1367,3	44,3	53,6

Vittoria



Bernard



Rustikal

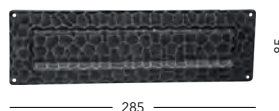

## Věšáky kované

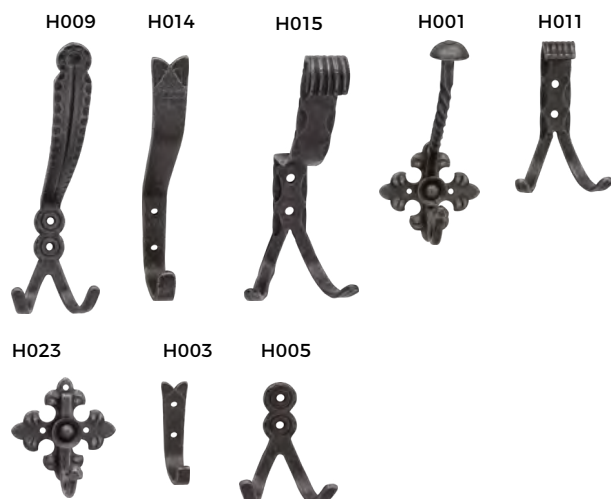

Povrch	typ provedení	obj. číslo	CZK	s DPH	EUR	s DPH
K	H001 80x160 mm	HAH001	475,0	574,8	18,6	22,5
K	H003 60 mm	HAH003	130,0	157,3	5,1	6,2
K	H005 70x90 mm	HAH005	230,0	278,3	9,0	10,9
K	H009 70x210 mm	HAH009	265,0	320,7	10,4	12,6
K	H011 65x105 mm	HAH011	210,0	254,1	8,2	10,0
K	H014 170 mm	HAH014	150,0	181,5	5,9	7,1
K	H015 70x170 mm	HAH015	265,0	320,7	10,4	12,6
K	H023 80x85 mm	HAH023	315,0	381,2	12,4	14,9

## Věšák



Povrch	typ provedení	obj. číslo	CZK	s DPH	EUR	s DPH
OCS	Věšák 2117	C2117CX90	165,0	199,7	6,5	7,8
ONS	Věšák 2117	C2117CX40	165,0	199,7	6,5	7,8
OLV	Věšák 2117	C2117CX20	165,0	199,7	6,5	7,8
BÍLÁ	Věšák 2117	C2117CX60	165,0	199,7	6,5	7,8
OCS	Věšák 2105	C2105CX90	165,0	199,7	6,5	7,8
OC	Věšák 2105	C2105CX10	165,0	199,7	6,5	7,8
ONS	Věšák 2105	C2105CX40	165,0	199,7	6,5	7,8
OFS	Věšák 2105	C2105CX30	165,0	199,7	6,5	7,8
OLV	Věšák 2105	C2105CX20	165,0	199,7	6,5	7,8
černá	Věšák 2105	C2105CX50	100,0	121,0	3,9	4,7
BÍLÁ	Věšák 2105	C2105CX60	165,0	199,7	6,5	7,8
OCS	Věšák 2120	C2120CX90	120,0	145,2	4,7	5,7
OC	Věšák 2120	C2120CX10	120,0	145,2	4,7	5,7
ONS	Věšák 2120	C2120CX40	120,0	145,2	4,7	5,7
OFS	Věšák 2120	C2120CX30	120,0	145,2	4,7	5,7
OLV	Věšák 2120	C2120CX20	85,0	102,9	3,3	4,0
černá	Věšák 2120	C2120CX50	120,0	145,2	4,7	5,7
BÍLÁ	Věšák 2120	C2120CX60	120,0	145,2	4,7	5,7
OCS	Věšák 2217	C2217CX90	80,0	96,8	3,1	3,8
OC	Věšák 2217	C2217CX10	80,0	96,8	3,1	3,8
ONS	Věšák 2217	C2217CX40	80,0	96,8	3,1	3,8
OCS	Věšák 2216	C2216CX90	130,0	157,3	5,1	6,2
OC	Věšák 2216	C2216CX10	130,0	157,3	5,1	6,2
ONS	Věšák 2216	C2216CX40	130,0	157,3	5,1	6,2
OFS	Věšák 2216	C2216CX30	130,0	157,3	5,1	6,2
OLV	Věšák 2216	C2216CX20	130,0	157,3	5,1	6,2
OCS	Věšák 2108	C2108CX90	50,0	60,5	2,0	2,4
OC	Věšák 2108	C2108CX10	50,0	60,5	2,0	2,4
ONS	Věšák 2108	C2108CX40	50,0	60,5	2,0	2,4
OLV	Věšák 2108	C2108CX20	50,0	60,5	2,0	2,4
černá	Věšák 2108	C2108CX50	50,0	60,5	2,0	2,4
BÍLÁ	Věšák 2108	C2108CX60	50,0	60,5	2,0	2,4

## Háčky

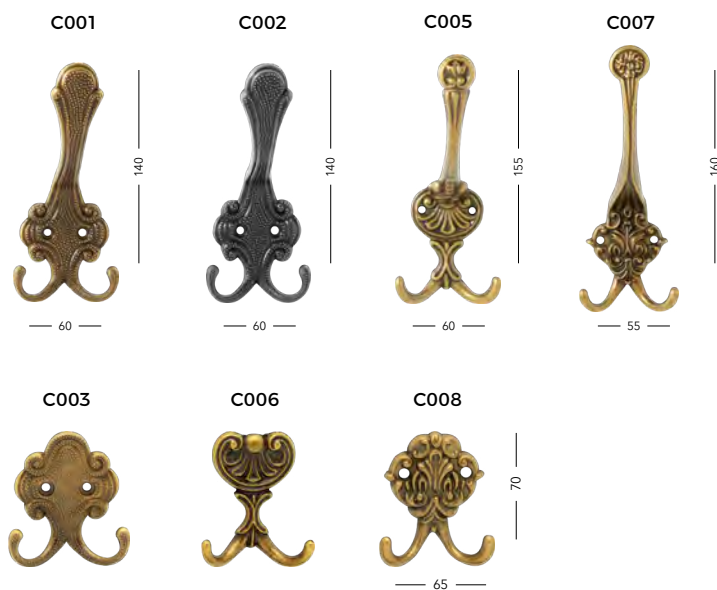

Povrch	typ provedení	obj. číslo	CZK	s DPH	EUR	s DPH
OFS	Háček C001	C001	60,0	72,6	2,4	2,8
K	Háček C002	C002	40,0	48,4	1,6	1,9
OFS	Háček C003	C003	30,0	36,3	1,2	1,4
OFS	Háček C005	C005	65,0	78,7	2,5	3,1
OFS	Háček C006	C006	30,0	36,3	1,2	1,4
OFS	Háček C007	C007	65,0	78,7	2,5	3,1
OFS	Háček C008	C008	25,0	30,3	1,0	1,2

## Držák na květináč

Povrch	typ provedení	obj. číslo	CZK	s DPH	EUR	s DPH
K	Držák 170 mm	HA23301	485,0	586,9	19,0	23,0
K	Držák 210 mm	HA23302	510,0	617,1	20,0	24,2



## Petlice na dveře

Povrch	typ provedení	obj. číslo	CZK	s DPH	EUR	s DPH
K	Petlice 200x65 mm	HA117003	1350,0	1633,5	52,9	64,1



# Zadlabací zámky

## Na posuvné dveře

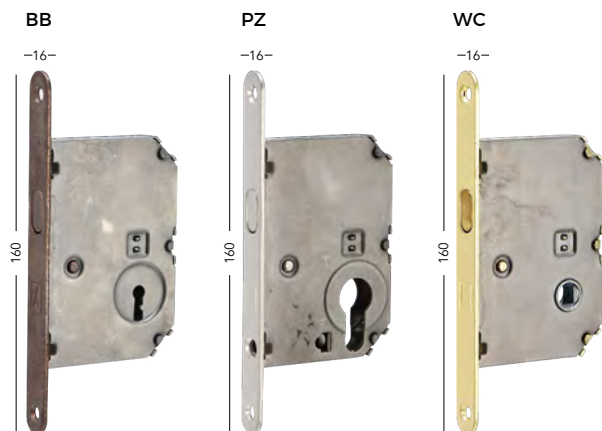

	Povrch	typ provedení	obj. číslo	CZK	s DPH	EUR	s DPH
🔑	OCS	BB 60/160	BT16009X10A	495,0	599,0	19,4	23,5
🔑	OCS	BB 70/160	BT16009X10B	495,0	599,0	19,4	23,5
🔑	OC	BB 60/160	BT16005X10A	495,0	599,0	19,4	23,5
🔑	OC	BB 70/160	BT16005X10B	495,0	599,0	19,4	23,5
🔑	ONS	BB 60/160	BT16006X10A	475,0	574,8	18,6	22,5
🔑	ONS	BB 70/160	BT16006X10B	475,0	574,8	18,6	22,5
🔑	OF	BB 60/160	BT16007X10A	475,0	574,8	18,6	22,5
🔑	OF	BB 70/160	BT16007X10B	475,0	574,8	18,6	22,5
🔑	OLV	BB 60/160	BT16001X10A	495,0	599,0	19,4	23,5
🔑	OLV	BB 70/160	BT16001X10B	495,0	599,0	19,4	23,5
🔑	OCS	PZ 50/160	BT16209X20A	495,0	599,0	19,4	23,5
🔑	OCS	PZ 70/160	BT16209X20B	495,0	599,0	19,4	23,5
🔑	OC	PZ 50/160	BT16205X20B	495,0	599,0	19,4	23,5
🔑	OC	PZ 70/160	BT16205X20A	495,0	599,0	19,4	23,5
🔑	ONS	PZ 70/160	BT16206X20B	475,0	574,8	18,6	22,5
🔑	OF	PZ 70/160	BT16207X20B	475,0	574,8	18,6	22,5
🔑	OLV	PZ 50/160	BT16201X20A	495,0	599,0	19,4	23,5
🔑	OLV	PZ 70/160	BT16201X20B	495,0	599,0	19,4	23,5
	OCS	WC 60/160	BT16109X30A	495,0	599,0	19,4	23,5
	OCS	WC 70/160	BT16109X30B	495,0	599,0	19,4	23,5
	OC	WC 60/160	BT16105X30A	495,0	599,0	19,4	23,5
	OC	WC 70/160	BT16105X30B	495,0	599,0	19,4	23,5
	ONS	WC 60/160	BT16106X30A	475,0	574,8	18,6	22,5
	ONS	WC 70/160	BT16106X30B	475,0	574,8	18,6	22,5
	OF	WC 60/160	BT16107X30A	475,0	574,8	18,6	22,5
	OF	WC 70/160	BT16107X30B	475,0	574,8	18,6	22,5
	OLV	WC 60/160	BT16101X30A	495,0	599,0	19,4	23,5
	OLV	WC 70/160	BT16101X30B	495,0	599,0	19,4	23,5

## Interiérové

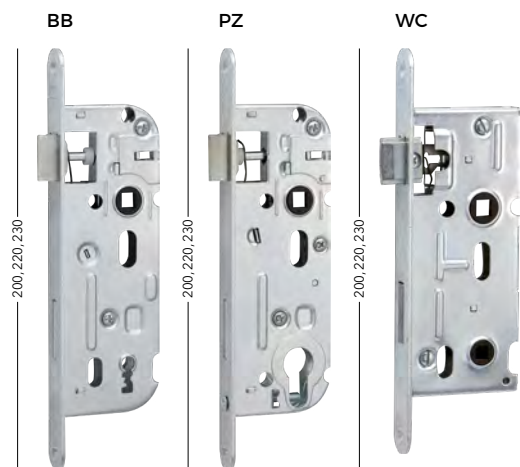

	Povrch	typ provedení	obj. číslo	CZK	s DPH	EUR	s DPH
🔑	POZINK	BB 72/60/200	21120740	240,0	290,4	9,4	11,4
🔑	POZINK	BB 72/80/220	21120640	305,0	369,1	12,0	14,5
🔑	POZINK	BB 90/60/230	21120840	240,0	290,4	9,4	11,4
🔑	POZINK	BB 90/80/230	21120540	250,0	302,5	9,8	11,9
🔑	POZINK	PZ 72/60/200	21120750	250,0	302,5	9,8	11,9
🔑	POZINK	PZ 72/80/220	21120650	315,0	381,2	12,4	14,9
🔑	POZINK	PZ 90/60/230	21120850	250,0	302,5	9,8	11,9
🔑	POZINK	PZ 90/80/230	21120550	240,0	290,4	9,4	11,4
🔑	POZINK	WC 72/60/200	21120760	275,0	332,8	10,8	13,0
🔑	POZINK	WC 72/80/220	21120660	275,0	332,8	10,8	13,0
🔑	POZINK	WC 90/60/230	21120860	315,0	381,2	12,4	14,9
🔑	POZINK	WC 90/80/230	21120560	350,0	423,5	13,7	16,6

## Protiplech



## Protiplech

Povrch	typ provedení	obj. číslo	CZK	s DPH	EUR	s DPH
POZINK	Protiplech+kapsy	CZP0016P	35,0	42,4	1,4	1,7
ZL.POZ.	Protiplech+kapsy	CZP0012P	35,0	42,4	1,4	1,7

## Interiérové panty

### Závěs 030



Povrch	typ provedení	obj. číslo	CZK s DPH	EUR s DPH
POMOS	Závěs 030 13 mm horní	CF030130O006	7,0 8,5	0,3 0,3
POMOS	Závěs 030 13 mm spodní	CG030130O004	10,0 12,1	0,4 0,5
POZINK	Závěs 030 13 mm horní	CF030130H021	8,0 9,7	0,3 0,4
POZINK	Závěs 030 13 mm spodní	CG030130H023	9,0 10,9	0,4 0,4

### Závěs 055



Povrch	typ provedení	obj. číslo	CZK s DPH	EUR s DPH
POMOS	Závěs 055 13 mm horní	CF055130O008	9,0 10,9	0,4 0,4
POMOS	Závěs 055 13 mm spodní	CG055130O010	10,0 12,1	0,4 0,5
POBR	Závěs 055 13 mm horní	CF055130BN12	8,0 9,7	0,3 0,4
POBR	Závěs 055 13 mm spodní	CG055130BN12	9,0 10,9	0,4 0,4
ONS	Závěs 055 13 mm horní	CF055130N402	22,0 26,6	0,9 1,0
ONS	Závěs 055 13 mm spodní	CG055130N402	25,0 30,3	1,0 1,2
PONIKL	Závěs 055 13 mm horní	CF055130N005	8,0 9,7	0,3 0,4
PONIKL	Závěs 055 13 mm spodní	CG055130N005	12,0 14,5	0,5 0,6
POMOS	Závěs 055 14 mm horní	CF055140O007	8,0 9,7	0,3 0,4
POMOS	Závěs 055 14 mm spodní	CG055140O005	12,0 14,5	0,5 0,6
POMOS	Závěs 055 14 mm spodní.WAS	CG055140O004	35,0 42,4	1,4 1,7

Povrch	typ provedení	obj. číslo	CZK s DPH	EUR s DPH
POBR	Závěs 055 14 mm horní	CF055140BN11	9,0 10,9	0,4 0,4
POBR	Závěs 055 14 mm spodní	CG055140BN11	12,0 14,5	0,5 0,6
PONIKL	Závěs 055 14 mm horní	CF055140N004	12,0 14,5	0,5 0,6
PONIKL	Závěs 055 14 mm spodní	CG055140N008	12,0 14,5	0,5 0,6
POMOS	Závěs 055 16 mm horní	CF055160O004	14,0 16,9	0,5 0,7
POMOS	Závěs 055 16 mm spodní	CG055160O004	18,0 21,8	0,7 0,9
POBR	Závěs 055 16 mm horní	CF055160BN04	12,0 14,5	0,5 0,6
POBR	Závěs 055 16 mm spodní	CG055160BN04	20,0 24,2	0,8 0,9
PONIKL	Závěs 055 16 mm horní	CF055160N006	14,0 16,9	0,5 0,7
PONIKL	Závěs 055 16 mm spodní	CG055160N006	18,0 21,8	0,7 0,9

### Závěs 100 / 101

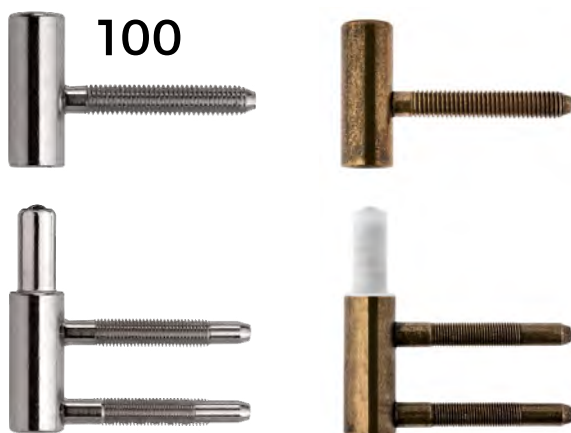

Povrch	typ provedení	obj. číslo	CZK s DPH	EUR s DPH
POMOS	Závěs 100 15 mm horní	CF100150O004	17,0 20,6	0,7 0,8
POMOS	Závěs 100 15 mm spodní	CG100150O013	20,0 24,2	0,8 0,9
BRONZ	Závěs 100 15 mm horní	CF100150B105	70,0 84,7	2,7 3,3
BRONZ	Závěs 100 15 mm spodní	CG100150B116	70,0 84,7	2,7 3,3
PONIKL	Závěs 100 15 mm horní	CF100150N007	18,0 21,8	0,7 0,9
PONIKL	Závěs 100 15 mm spodní	CG100150N026	22,0 26,6	0,9 1,0
POZINK	Závěs 100 15 mm horní	CF100150H004	13,0 15,7	0,5 0,6
POZINK	Závěs 100 15 mm spodní	CG100150H017	18,0 21,8	0,7 0,9
ONS	Závěs 100 15 mm horní	CF100150N402	35,0 42,4	1,4 1,7
ONS	Závěs 100 15 mm spodní	CG100150N406	60,0 72,6	2,4 2,8
ONS	Závěs 101 15 mm spodní	CG101150N406	60,0 72,6	2,4 2,8
černá	Závěs 101 15 mm spodní	CG101150C406	60,0 72,6	2,4 2,8



## Závěs 180



Povrch	typ provedení	obj. číslo	CZK	s DPH	EUR	s DPH
POMOS	Závěs 180 16 mm horní	CF180160O004	31,0	37,5	1,2	1,5
POMOS	Závěs 180 16 mm spodní	CG180160O004	33,0	39,9	1,3	1,6
BRONZ	Závěs 180 16 mm horní	CF180160B104	38,0	46,0	1,5	1,8
BRONZ	Závěs 180 16 mm spodní	CG180160B106	40,0	48,4	1,6	1,9

## Závěs 190



Povrch	typ provedení	obj. číslo	CZK	s DPH	EUR	s DPH
POMOS	Závěs 190 13 mm horní	CF190130O006	13,0	15,7	0,5	0,6
POMOS	Závěs 190 13 mm spodní	CG190130O006	14,0	16,9	0,5	0,7
POBR	Závěs 190 13 mm horní	CF190130BN06	13,0	15,7	0,5	0,6
POBR	Závěs 190 13 mm spodní	CG190130BN06	14,0	16,9	0,5	0,7
BRONZ	Závěs 190 13 mm horní	CF190130B110	17,0	20,6	0,7	0,8
BRONZ	Závěs 190 13 mm spodní	CG190130B112	13,0	15,7	0,5	0,6
POMOS	Závěs 190 14 mm horní	CF190140O004	14,0	16,9	0,5	0,7
POMOS	Závěs 190 14 mm spodní	CG190140O004	16,0	19,4	0,6	0,8

Povrch	typ provedení	obj. číslo	CZK	s DPH	EUR	s DPH
POBR	Závěs 190 14 mm horní	CF190160BN04	15,0	18,2	0,6	0,7
POBR	Závěs 190 14 mm spodní	CG190140BN04	16,0	19,4	0,6	0,8
POMOS	Závěs 190 16 mm horní	CF190160O002	20,0	24,2	0,8	0,9
POMOS	Závěs 190 16 mm spodní	CG190160O002	21,0	25,4	0,8	1,0
POBR	Závěs 190 16 mm horní	CF190160BN04	20,0	24,2	0,8	0,9
POBR	Závěs 190 16 mm spodní	CG190160BN04	22,0	26,6	0,9	1,0
BRONZ	Závěs 190 16 mm horní	CF190160BN04	20,0	24,2	0,8	0,9
BRONZ	Závěs 190 16 mm spodní	CG190160BN04	22,0	26,6	0,9	1,0

## Závěs 221

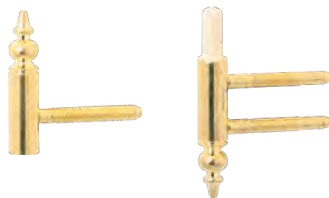

Povrch	typ provedení	obj. číslo	CZK	s DPH	EUR	s DPH
POMOS	Závěs 221 15 mm horní	CF2211500O002	52,0	62,9	2,0	2,5
POMOS	Závěs 221 15 mm spodní	CG2211500O003	60,0	72,6	2,4	2,8
BRONZ	Závěs 221 15 mm horní	CF2211500B102	54,0	65,3	2,1	2,6
BRONZ	Závěs 221 15 mm spodní	CG2211500B105	74,0	89,5	2,9	3,5

## Závěs 300



Povrch	typ provedení	obj. číslo	CZK	s DPH	EUR	s DPH
POBR	Závěs 300 14 mm	CI300140BN04	34,0	41,1	1,3	1,6
POBR	Závěs 300 16 mm	CI300160H104	38,0	46,0	1,5	1,8

## Závěs 320

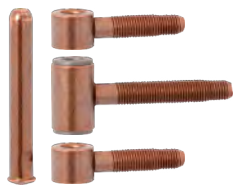

Povrch	typ provedení	obj. číslo	CZK	s DPH	EUR	s DPH
POMOS	Závěs 320 16 mm	CI320160O006	67,0	81,1	2,6	3,2
POBR	Závěs 320 16 mm	CI320160BN04	60,0	72,6	2,4	2,8
POMOS	Závěs 320 18 mm	CI320180O006	74,0	89,5	2,9	3,5
POBR	Závěs 320 18 mm	CI320180B004	72,0	87,1	2,8	3,4
POMOS	Závěs 320 20 mm	CI320200O008	102,0	123,4	4,0	4,8
POBR	Závěs 320 20 mm	CI320200BN08	97,0	117,4	3,8	4,6

## Závěs 330

Povrch	typ provedení	obj. číslo	CZK	s DPH	EUR	s DPH
POMOS	Závěs 330 16 mm	CI330160O008	146,0	176,7	5,7	6,9
POBR	Závěs 330 16 mm	CI330160B106	146,0	176,7	5,7	6,9



## Závěs 488

Povrch	typ provedení	obj. číslo	CZK	s DPH	EUR	s DPH
POZINK	Závěs 488 16 mm pravý	CI488160H504	495,0	599,0	19,4	23,5
POZINK	Závěs 488 16 mm levý	CI488160H506	495,0	599,0	19,4	23,5

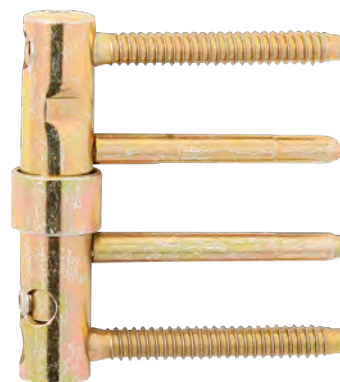

## Závěs 495

Povrch	typ provedení	obj. číslo	CZK	s DPH	EUR	s DPH
POZINK	Závěs 495 14 mm horní	CF495140H519	48,0	58,1	1,9	2,3
POZINK	Závěs 495 14 mm spodní	CG495140H502	77,0	93,2	3,0	3,7
POZINK	Závěs 495 16 mm horní	CF495160H502	65,0	78,7	2,5	3,1



Povrch	typ provedení	obj. číslo	CZK	s DPH	EUR	s DPH
POZINK	Závěs 495 16 mm spodní	CG495160H502	95,0	115,0	3,7	4,5
POZINK	Závěs 495 16 mm sp. WAS	CF495160H504	130,0	157,3	5,1	6,2
POZINK	Závěs 495 20 mm horní	CF495200H502	101,0	122,2	4,0	4,8
POZINK	Závěs 495 20 mm spodní	CG495200H502	122,0	147,6	4,8	5,8
POZINK	Závěs 495 20 mm sp. WAS	CF495200H505	186,0	225,1	7,3	8,8

## Skrytý pant

do 35 kg



do 50 kg



Povrch	typ provedení	obj. číslo	CZK	s DPH	EUR	s DPH
ONS	Nastavitelný do 50 kg	IN300120VN02	830,0	1004,3	32,5	39,4
PONIKL	Nastavitelný do 50 kg	IN300120H004	740,0	895,4	29,0	35,1
POZINK	Nastavitelný do 50 kg	IN300120V702	830,0	1004,3	32,5	39,4
POBR	Nastavitelný do 50 kg	IN300120BO02	92,0	111,3	3,6	4,4
BÍLÁ	Nastavitelný do 50 kg	IN3001209P02	832,0	1006,7	32,6	39,5
ONS	Pevný do 35 kg	IN301090V702	410,0	496,1	16,1	19,5
POBR	Pevný do 35 kg	IN301090BO02	440,0	532,4	17,3	20,9
ONS	Krytka skrytý pant 1 ks	GC300010J205	40,0	48,4	1,6	1,9
POZINK	Krytka skrytý pant 1 ks	GC300010J102	40,0	48,4	1,6	1,9
POBR	Krytka skrytý pant 1 ks	GC3000109R02	40,0	48,4	1,6	1,9
BÍLÁ	Závěs 605 11 mm spodní	CG605110B107	40,0	48,4	1,6	1,9

## Návlek k závěsu 495



Povrch	typ provedení	obj. číslo	CZK	s DPH	EUR	s DPH
OLV	Krytka Ø 16 mm	GC838160L103	94,0	113,7	3,7	4,5
OLV	Krytka Ø 18 mm	GC838180L104	101,0	122,2	4,0	4,8
OLV	Krytka Ø 22 mm	GC838220L104	198,0	239,6	7,8	9,4
POBR	Krytka Ø 16 mm	GC838160B003	65,0	78,7	2,5	3,1
ONS	Krytka Ø 16 mm hranatá	GC901160M702	76,0	92,0	3,0	3,6
ZLATÁ	Krytka Ø 16 mm hranatá	GC901160MK02	76,0	92,0	3,0	3,6
POBR	Krytka Ø 18 mm	GC838180B004	140,0	169,4	5,5	6,6
POBR	Krytka Ø 22 mm	GC838220B004	164,0	198,4	6,4	7,8
ZLATÁ	Krytka Ø 16 mm plast	GC838150JO04	63,0	76,2	2,5	3,0
ZLATÁ	Krytka Ø 18 mm plast	GC838170JO02	94,0	113,7	3,7	4,5
ZLATÁ	Krytka Ø 22 mm plast	GC838210JO02	118,0	142,8	4,6	5,6
BÍLÁ	Krytka Ø 16 mm plast	GC838160Y301	22,0	26,6	0,9	1,0
BÍLÁ	Krytka Ø 18 mm plast	GC838180Y303	22,0	26,6	0,9	1,0

Povrch	typ provedení	obj. číslo	CZK	s DPH	EUR	s DPH
BÍLÁ	Krytka Ø 22 mm plast	GC838220Y301	30,0	36,3	1,2	1,4
OC	Krytka Ø 15 mm plast	GC838150JI02	38,0	46,0	1,5	1,8
OC	Krytka Ø 18 mm plast	GC838180YB01	94,0	113,7	3,7	4,5
ONS	Krytka Ø 16 mm plast	GC838160YC01	115,0	139,2	4,5	5,5
ONS	Krytka Ø 18 mm plast	GC838180YC01	157,0	190,0	6,2	7,4
ONS	Krytka Ø 22 mm plast	GC838220YC01	185,0	223,9	7,3	8,8
F4	Krytka Ø 16 mm plast	GC838150JZ02	78,0	94,4	3,1	3,7
F4	Krytka Ø 18 mm plast	GC838170JZ02	80,0	96,8	3,1	3,8
F4	Krytka Ø 22 mm plast	GC838210JZ02	100,0	121,0	3,9	4,7

## Závěs 530



Povrch	typ provedení	obj. číslo	CZK	s DPH	EUR	s DPH
POMOS	Závěs 530 9 mm horní	CF530090O004	5,0	6,1	0,2	0,2
POMOS	Závěs 530 9 mm spodní	CG530090O006	6,0	7,3	0,2	0,3
POBR	Závěs 530 9 mm horní	CF530090BN08	5,0	6,1	0,2	0,2
POBR	Závěs 530 9 mm spodní	CG530090BN14	6,0	7,3	0,2	0,3
POZINK	Závěs 530 9 mm horní	CF530090H008	3,0	3,6	0,1	0,1
POZINK	Závěs 530 9 mm spodní	CG530090H008	5,0	6,1	0,2	0,2
PONIKL	Závěs 530 9 mm horní	CF530090N002	3,0	3,6	0,1	0,1
PONIKL	Závěs 530 9 mm spodní	CG530090N002	5,0	6,1	0,2	0,2
POMOS	Závěs 530 11 mm horní	CF530110O002	6,0	7,3	0,2	0,3
POMOS	Závěs 530 11 mm spodní	CG530110O002	7,0	8,5	0,3	0,3
POZINK	Závěs 530 11 mm horní	CF530110H006	5,0	6,1	0,2	0,2
POZINK	Závěs 530 11 mm spodní	CG530110H004	6,0	7,3	0,2	0,3

## Závěs 605

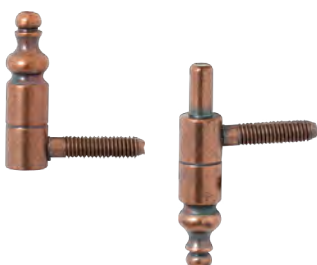

Povrch	typ provedení	obj. číslo	CZK	s DPH	EUR	s DPH
POMOS	Závěs 605 9 mm horní	CF605090O006	7,0	8,5	0,3	0,3
POMOS	Závěs 605 9 mm spodní	CG605090O008	8,0	9,7	0,3	0,4
POBR	Závěs 605 9 mm horní	CF605090BN09	6,0	7,3	0,2	0,3
POBR	Závěs 605 9 mm spodní	CG605090BN15	7,0	8,5	0,3	0,3
BRONZ	Závěs 605 9 mm horní	CF605090B106	6,0	7,3	0,2	0,3
BRONZ	Závěs 605 9 mm spodní	CG605090B108	7,0	8,5	0,3	0,3
POMOS	Závěs 605 11 mm horní	CF605110O003	11,0	13,3	0,4	0,5
POMOS	Závěs 605 11 mm spodní	CG605110O003	12,0	14,5	0,5	0,6
POBR	Závěs 605 11 mm horní	CF605110BN03	11,0	13,3	0,4	0,5
POBR	Závěs 605 11 mm spodní	CG605110BN03	12,0	14,5	0,5	0,6
BRONZ	Závěs 605 11 mm horní	CF605110B105	11,0	13,3	0,4	0,5
BRONZ	Závěs 605 11 mm spodní	CG605110B107	12,0	14,5	0,5	0,6

## Krytka ozdobná k závěsu 495



Povrch	typ provedení	obj. číslo	CZK	s DPH	EUR	s DPH
OLV	Krytka 16 mm	GC839160L103	123,0	148,8	4,8	5,8
OLV	Krytka 18 mm	GC839180L103	157,0	190,0	6,2	7,4
OLV	Krytka 22 mm	GC839220L103	291,0	352,1	11,4	13,8
POBR	Krytka 16 mm	GC839160BN03	117,0	141,6	4,6	5,6
POBR	Krytka 18 mm	GC839220L103	123,0	148,8	4,8	5,8
POBR	Krytka 22 mm	GC839220BN04	245,0	296,5	9,6	11,6

## Záklopka dveří



- 15 -

Povrch	typ provedení	obj. číslo	CZK	s DPH	EUR	s DPH
POBR	Záklopka 160 mm	LC260160B002	83,0	100,4	3,3	3,9
POBR	Záklopka 200 mm	LC260200B002	88,0	106,5	3,5	4,2
POBR	Záklopka 250 mm	LC260250B002	93,0	112,5	3,6	4,4
POBR	Záklopka 300 mm	LC260300B002	93,0	112,5	3,6	4,4
POBR	Záklopka 400 mm	LC260400B002	120,0	145,2	4,7	5,7
POBR	Záklopka 500 mm	LC260500B002	131,0	158,5	5,1	6,2
POBR	Záklopka 600 mm	LC260600B002	196,0	237,2	7,7	9,3
POZINK	Záklopka 160 mm	LC260160H002	72,0	87,1	2,8	3,4
POZINK	Záklopka 200 mm	LC260200H002	60,0	72,6	2,4	2,8
POZINK	Záklopka 250 mm	LC260250H004	61,0	73,8	2,4	2,9
POZINK	Záklopka 300 mm	LC260300H002	66,0	79,9	2,6	3,1
POZINK	Záklopka 400 mm	LC260400H002	66,0	79,9	2,6	3,1
POMOS	Záklopka 160 mm	LC260160O002	59,0	71,4	2,3	2,8
POMOS	Záklopka 200 mm	LC260200O002	77,0	93,2	3,0	3,7
POMOS	Záklopka 250 mm	LC260250O002	77,0	93,2	3,0	3,7
POMOS	Záklopka 300 mm	LC260300O002	87,0	105,3	3,4	4,1
POMOS	Záklopka 400 mm	LC260400O002	110,0	133,1	4,3	5,2
POMOS	Záklopka 500 mm	LC260500O002	120,0	145,2	4,7	5,7
POMOS	Záklopka 600 mm	LC260600O002	180,0	217,8	7,1	8,5
PONIKL	Záklopka 160 mm	LC260160N006	72,0	87,1	2,8	3,4

## Závěs kyvných dveří

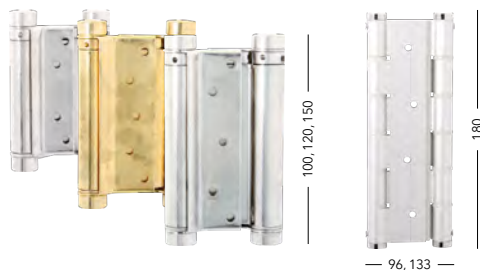

Povrch	typ provedení	obj. číslo	CZK	s DPH	EUR	s DPH
OF	Závěs 100 mm	21179020P	530,0	641,3	20,8	25,1
OLV	Závěs 100 mm	21179000P	650,0	786,5	25,5	30,8
PONIKL	Závěs 100 mm	21179010P	530,0	641,3	20,8	25,1
OF	Závěs 125 mm	21179120P	680,0	822,8	26,7	32,3
OLV	Závěs 125 mm	21179100P	680,0	822,8	26,7	32,3
PONIKL	Závěs 125 mm	21179110P	680,0	822,8	26,7	32,3
OF	Závěs 150 mm	21179220P	935,0	1131,4	36,7	44,4
OLV	Závěs 150 mm	21179200P	935,0	1131,4	36,7	44,4
PONIKL	Závěs 150 mm	21179210P	935,0	1131,4	36,7	44,4

Povrch	typ provedení	obj. číslo	CZK	s DPH	EUR	s DPH
F1	Závěs 180x96 mm	7J5904F1	1665,0	2014,7	65,3	79,0
F4	Závěs 180x96 mm	7J5904F4	1745,0	2111,5	68,4	82,8
F1	Závěs 180x133 mm	7J5914F1	1550,0	1875,5	60,8	73,5
F4	Závěs 180x133 mm	7J5914F4	1615,0	1954,2	63,3	76,6
BILÁ	Závěs 180x133 mm	7J5914PX	1615,0	1954,2	63,3	76,6

## Závěs kovaný

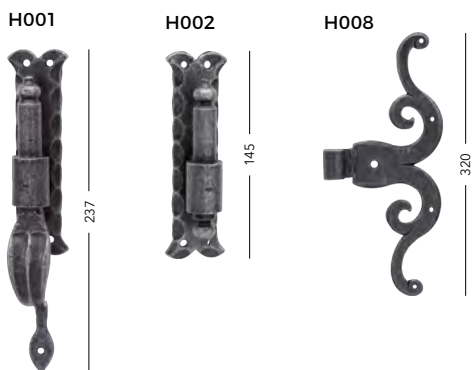

Povrch	typ provedení	obj. číslo	CZK	s DPH	EUR	s DPH
K	Závěs H001 23 cm dolní	HA129X001	1450,0	1754,5	56,9	68,8
K	Závěs H002 14,5 cm dolní	HA129X002	1150,0	1391,5	45,1	54,6
K	Závěs H008 32 cm horní	HA127X008	1210,0	1464,1	47,5	57,4
K	Závěs H011 42 cm horní	HA127X011	1280,0	1548,8	50,2	60,7
K	Závěs H025 39 cm horní	HA127X025	1485,0	1796,9	58,2	70,5
K	Závěs H027 60 cm horní	HA127X027	1430,0	1730,3	56,1	67,9

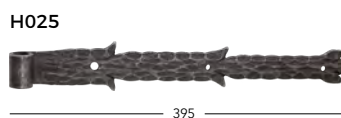

## Kování na sklo

formspiele®

## ČERNÁ MATNÁ - FORMSPIELE SET



## Kování na sklo formspiele®

Standardní set se zámkem, klikou 3 dílným pantem hranatým pro dřevěnou zárubeň, extra střelka pro sklo s tloušťkou nad 8 mm. formspiele set Form B pro pasivní křídlo (protikus dlouhý, 3-dílný pant hranatý, držák na sklo). Termín dodání 14dní od objednání.

## PRÉMIOVÉ POVRCHY:



Titanium matná



Nickel matná



PVD měď matná



Kování na sklo Formspiele typ B s klikou 8106

Název	CZK	S DPH	EUR	S DPH
Set kování slepý	10450,0	12645,0	401,85	482,22
Set kování BB/PZ	10840,0	13116,0	416,85	500,22
Set kování WC	11620,0	14060,0	446,85	536,22

Kování na sklo Formspiele typ B s klikou 8040

Název	CZK	S DPH	EUR	S DPH
Set kování slepý	10450,0	12644,50	401,85	482,22
Set kování BB/PZ	10840,0	13116,40	416,85	500,22
Set kování WC	11620,0	14060,20	446,85	536,22

## Vrtání sklo zámeček

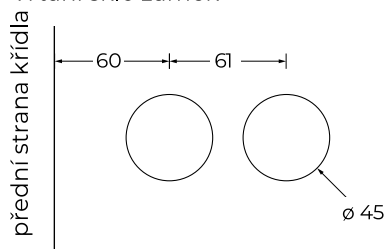

## Vrtání sklo 3 dílný pant

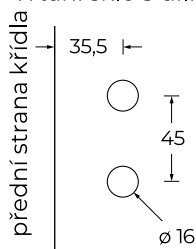

## Vrtání sklo 2 dílný pant

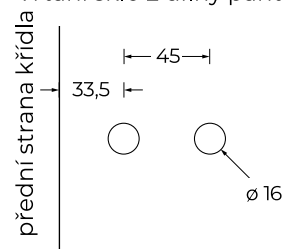

slepý

BB

PZ

WC vnitřní

WC venkovní

formspiele®

## NEREZ MAT - SET PRÉMIUM



## Kování na sklo Prémiové

Nerezový zámek, klika, 3 dílný nerezový pant hranatý pro dřevěnou zárubeň a extra střelka pro sklo s tloušťkou nad 8 mm.

## PRÉMIOVÉ POVRCHY:



Nerez leštěná



PVD mosaz leštěná



Kování na sklo prémiové typ A s klikou 1106

Název	CZK	S DPH	EUR	S DPH
Set kování slepý	4605,0	5572,05	177,2	212,64
Set kování BB/PZ	4930,0	5965,3	189,6	227,52
Set kování WC	5580,0	6751,8	214,6	257,52



Kování na sklo prémiové typ B s klikou 1005

Název	CZK	S DPH	EUR	S DPH
Set kování slepý	5580,0	6751,8	214,5	257,4
Set kování BB/PZ	5900,0	7139,0	189,6	227,52
Set kování WC	6550,0	7925,5	214,6	257,52



Kování na sklo prémiové typ B s klikou 1106

Název	CZK	S DPH	EUR	S DPH
Set kování slepý	4605,0	5572,05	177,2	212,64
Set kování BB/PZ	4930,0	5965,3	189,6	227,52
Set kování WC	5580,0	6751,8	214,6	257,52



Kování na sklo typ B s klikou 1005

Název	CZK	S DPH	EUR	S DPH
Set kování slepý	5580,0	6751,8	214,5	257,4
Set kování BB/PZ	5900,0	7139,0	189,6	227,52
Set kování WC	6550,0	7925,5	214,6	257,52



Kování na sklo prémiové typ C s klikou 1106

Název	CZK	S DPH	EUR	S DPH
Set kování slepý	4605,0	5572,05	177,2	212,64
Set kování BB/PZ	4930,0	5965,3	189,6	227,52
Set kování WC	5580,0	6751,8	214,6	257,52



Kování na sklo prémiové typ C s klikou 1005

Název	CZK	S DPH	EUR	S DPH
Set kování slepý	5580,0	6751,8	214,5	257,4
Set kování BB/PZ	5900,0	7139,0	189,6	227,52
Set kování WC	6550,0	7925,5	214,6	257,52

## Kování na sklo

formspiele®

## Alternativní panty k prémiovým setům

3-dílný pant hranatý(standard)  
nerez matná2-dílný pant hranatý  
nerez matnádílný pant zaoblený  
nerez matná2-dílný pant zaoblený  
nerez matná

## Příslušenství na dotaz

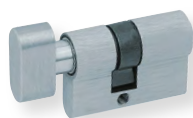
proti kus dlouhý  
nerez matnáproti kus krátký  
nerez matnáproti kus dlouhý  
nerez matnáproti kus krátký  
nerez matnávločka s knoflíkem  
nikl satínDržák dveří  
nerez matná

## Vložka s knoflíkem

Název	CZK	S DPH	EUR	S DPH
26/17		99,90		249,9
17/26		99,90		249,9

## Držák dveří

CZK	S DPH	EUR	S DPH
	99,90		249,9
	99,90		249,9



formspiele®

**EKONOMICKÝ SET - BEZ MOŽNOSTI KOMBINACE**

3-dílný pant nikl mat



2-dílný pant nikl mat

**Ekonomický seta**

Nerezový zámek, nerezová klika, panty hranaté nikl mat.  
Termín dodání 14dní od objednání.

**PRÉMIOVÉ POVRCHY:****Nerez leštěná****PVD mosaz leštěná****Kování na sklo Economy typ B s klikou 1106**

Název	CZK	S DPH	EUR	S DPH
Set kování slepý	2925,0	3539,25	114,7	137,64
Set kování PZ	2925,0	3539,25	114,7	137,64





# POPRODEJNÍ SERVIS, ZÁRUKY, MONTÁŽ A ÚDRŽBA

COBRA ručí za spolehlivé fungování. Prodejem naše péče o zákazníky nekončí. Pečlivě a systematicky rozvíjíme a podporujeme síť našich partnerů, kteří jsou díky tomu vždy připraveni poskytnout Vám poprodejní služby spojené s údržbou našich výrobků nebo s dodávkou náhradních dílů.

## COBRA®

### ZÁRUKY

Za naše výrobky a služby ručíme. Na naše výrobky poskytujeme záruky v rozsahu od dvou do deseti let. Na kliky COBRA se můžete spolehnout.

### ZÁRUKA AŽ 10 LET

Na vybrané kování COBRA poskytujeme záruku až 5 let, na designové kování CONVEX až 10 let.

### MONTÁŽ & ÚDRŽBA

Montáž klik provádíme vždy podle příbalového letáku a doporučujeme použít naši montážní šablonu. Aby Vám výrobky COBRA dlouho sloužily, doporučujeme jejich pravidelnou kontrolu, údržbu a čištění. Údržba klik není nijak náročná, spočívá především v kontrole stavu a kvality. Každého půl roku provedeme utažení všech spojovacích šroubů. Mechanismus promažeme vazelínou.

Můžete se setkat s mechanickým poškozením způsobeným hrubým nebo neopatrným zacházením. V takovém případě se obraťte na některého z našich partnerů, který Vám ochotně a profesionálně poradí, jak se s poškozením vypořádat. Do opravy kování sami nezasahujeme, vždy se raději poraďte s odborníkem.

Díky tradici a dostupnosti výrobků COBRA se dá očekávat, že Váš zvolený model kliky bude ještě dlouho dostupný. Pro čištění od prachu, nebo jiných nečistot použijte suchý nebo ve vodě navlhčený jemný hadřík. Nepoužívejte brusné a chemické přípravky. Při použití chemických prostředků hrozí oxidace materiálů, a tudíž poškození výrobku. Nerezové kování splňuje nejvyšší nároky odolnosti proti mechanickému poškození a při jeho údržbě lze použít i vhodné čisticí přípravky. Jeho montáž doporučujeme v provozech, které musí splňovat hygienické podmínky.

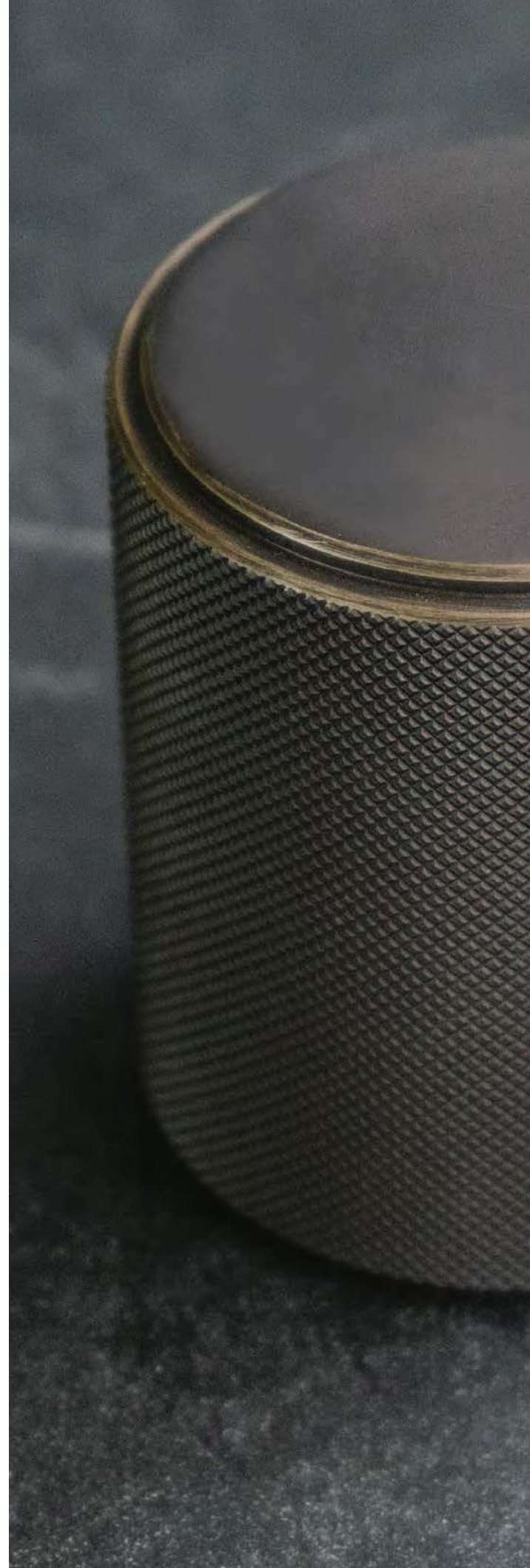

## AFTER SALES SERVICE, GUARANTEES. MOUNTING AND MAINTENANCE

COBRA guarantees reliable functioning. Selling our product does not mean the end of our customer care. We carefully and systematically develop and support network of our business partners who are thus ready to provide you with after sales services related to our products' maintenance as well as with the delivery of spare parts.

### GUARANTEES

Our products and services are guaranteed. We provide guarantees on our products ranging from two to ten years. COBRA handles can be relied on.

### GUARANTEE UP TO 10 YEARS

We provide a guarantee up to 5 years for selected COBRA fittings and up to 10 years for a design CONVEX fitting.

### MOUNTING & MAINTENANCE

Mounting of the fitting is always carried out in accordance with the package leaflet. We would also like to advise you to use our mounting template if possible. In order to gain the best performance of all COBRA products, their regular checking, maintenance and cleaning is strongly recommended.

The maintenance of handles is not a demanding job to do, it basically consists of checking the quality and condition. Every six months all the fastening screws are tightened and the entire mechanism is greased with petroleum jelly. You can also encounter some mechanical damage caused by careless or rough handling. In that case feel free to contact any of our business partners who will provide you with a professional advice on how to handle the whole issue. It is advisable not to try to fix the fitting by yourselves and consult the matter with an expert.

Thanks to a long tradition and availability of COBRA products it can be expected that the particular type of handle which you have chosen is going to be available for many years to come. In order to remove dust or any other impurities off the handle dry or fine damp piece of cloth is recommended to be used. Do not use any abrasive or chemical products. If any chemical product is used, it may result in oxidation of the material and subsequent damage of the product.

Stainless fitting meets the highest standards for durability and resistance against mechanical damage. During its maintenance any suitable detergent can be used. We strongly recommend to mount our products in places where complying with health conditions is a crucial point.

## PREMIUM

21 Infinity  
21 Spectra  
21 Ultima  
22 Kanelaz 1745

IN  
Nerez Classic

26 Bianca-R  
26 Giussy-R  
26 Giussy-S  
26 Nova-S  
26 Sali-R  
26 Sali-S  
27 Gaia-S  
27 Ufo-R  
27 Vision-R  
27 Vision-R plochá rozeta  
27 Vision-S  
27 Vision-S plochá rozeta

28 Koule pevná Star  
28 Koule pevná Stella

IN  
Nerez Object

32 Diva-R III  
32 Element-R III  
32 Giussy  
32 Giussy-S III  
32 Giussy-R III  
33 Iris-S III  
33 Iris-R III  
33 Loft  
33 Loft-R III  
33 Loft-R ovál III  
34 Paola  
34 Paola-R III  
34 Pavla-S III  
34 Pavla-R III  
34 Pavla-H  
34 Plaza  
35 Plaza-H  
35 Plaza-R III  
35 Plaza-S III  
35 Sali  
35 Sali-R III  
35 Sali-S III  
36 Ufo  
36 Ufo Slim  
36 Ufo-R III  
36 Ufo-R ovál III  
36 Vision

36 Vision-R ovál III  
37 Vision-R III  
37 Vision-S III  
37 Zoe-R III  
37 Koule pevná Luna  
37 Koule pevná Star  
37 Koule pevná Stella

IN  
Nerez Project

41 Loft  
41 Loft-krátký štít  
41 Loft-R  
41 Loft-ovál  
43 Ufo  
43 Ufo-krátký štít  
43 Ufo-R  
43 Ufo-ovál  
45 Vision  
45 Vision-krátký štít  
45 Vision-R  
45 Vision-ovál

OCS  
Chrom matný

48 Alexis-R  
48 Alt-wien  
48 Elegant  
48 Elsa-S  
48 Esme-S  
48 Spring-S  
49 Jerome-R  
49 Laura  
49 Laura-R  
49 Mega-S  
49 Milena  
50 Milena-R  
50 Orion  
50 Orion-R  
50 Q-arte  
50 Q-arte-S  
51 865  
51 1085  
51 1115  
51 1145  
51 1485  
51 1495  
51 1515  
52 1555

52 1505  
52 Koule pevná Victory

OC  
Chrom lesklý

56 Alt-wien  
56 Elegant  
56 Laura  
56 Laura-R  
56 Orion-R  
56 1105  
57 1485  
57 1495  
57 1505  
57 1515

ONS  
Nikl matný

60 Alexis  
60 Alexis-R  
60 Alt-Wien  
60 Aphrodité-S  
60 Athena-S  
60 Beata-S  
61 Denisa  
61 Denisa-R  
61 Elegant  
61 Element  
61 Element-R  
61 Elsa-S  
62 Esme-S  
62 Fap  
62 Fap-R  
62 Laura  
62 Laura-R  
63 Milena  
63 Milena-R  
63 Omega-S  
63 Orion  
63 Orion-R  
64 Q-arte  
64 Q-arte-S  
64 Spring-S  
64 Vega-S  
64 Vera-S  
64 Zeus  
65 Zeus-R III  
65 Zoe-R  
65 865  
65 1085  
65 1115  
65 1145  
66 1495  
66 1555  
66 Koule pevná Victory

ČERNÁ/TITAN  
Černá/titan

70 Aphrodité-S  
70 Athena-S  
70 Gaia-S  
70 Gabri-S  
70 Giussy-R  
70 Linda-S  
71 Omega-S  
71 Vega-S  
71 Vera-S  
71 Vision-R III  
71 Zoe-R  
71 865  
72 1495  
72 1555  
72 Koule pevná Victory

OCN  
Chrom lesk. / Nikl matný

76 Gabri  
76 Gabri-R  
76 Gabri-S  
76 Giussy-R  
76 Nicol-R  
76 Nicol-S  
77 Sharon-R  
77 Vanda-R  
77 Koule pevná Victory

OFS  
Bronz česaný

80 Alt-Wien  
80 Atlantis  
80 Dea  
80 Dea-R  
80 Elegant  
80 Florence  
81 Giussy-R  
81 Ikarus  
81 Kristina  
81 Kristina-R  
81 Laura  
81 Laura-R  
82 Milena  
82 Münster  
82 Sina  
82 Sina-R  
82 Venezia  
82 Vera-S  
83 Zoe-R  
83 Koule pevná Victory

## OLV

Mosaz leštěná

86 Alt-Wien  
86 Atlantis  
86 Elegant  
86 Ikarus  
86 Kristina  
86 Kristina-R  
87 Laura  
87 Laura-R  
87 Münster

## OV

Staromosaz

89 Alt-wien  
89 Elegant  
89 1115  
89 1085

## K

Kované a rustikální kování

92 Alt-Wien  
92 Atlantis  
92 Atlantis-R  
92 Baden  
92 Baden+  
92 Baden-S  
93 Baden-S+  
93 Berlin  
93 Bremen  
93 Burg-R  
93 Elegant  
94 Hamburg  
94 Hamburg-R  
94 Hamburg-R+  
94 Imst+  
94 Imst-R  
94 Innsbruck  
95 Innsbruck-R  
95 Regen  
95 Salzburg  
95 Salzburg-S  
95 Venezia  
95 Venezia-R  
96 Vienna-R+  
96 Koule pevná Bonn HR  
96 Koule pevná Linz

## BK

Bezpečnostní  
a ochranné kování

100 Alt-wien  
100 Alt-wien+  
100 C101+  
100 C201  
100 C301  
101 C501+  
101 Elegant  
101 Elegant+  
101 Mars-S+  
101 Slim-2  
102 Sveva  
102 Sveva+  
102 Titan  
102 Titan+  
102 Tower  
103 Tower+  
103 Tower-H  
104 Tower-H+  
104 Rozeta Tower  
104 Přídavná rozeta hranatá  
104 Přídavná rozeta kulatá  
104 Přídavná rozeta oválná

## S

Sety

108 Set Alt-wien  
109 Set Vision  
110 Set hliník

## F1

Stříbrný elox

114 Monet  
114 Monet-R  
114 Universal  
114 Universal-R

## F4

Bronzový elox

118 Monet  
118 Monet-R  
118 Universal  
118 Universal-R

## OKENNÍ KOVÁNÍ

122 Alt-wien  
123 Elegant  
124 F1  
124 F4  
125 Kované  
125 Vision

## MADLA / ÚCHYTY

128 Madla Inox  
128 Madla  
130 Madlo Bregenz  
130 Madlo Stein  
131 Madla na míru jednostranná  
132 Madla na míru oboustranná  
132 Posuvný systém  
133 Náprstky MQ  
133 Náprstky MT  
133 Úchyt 3663  
133 Úchyt 3665  
134 Úchyt 3666 Kulatá  
134 Úchyt 3667 Hranatá  
134 Úchyty  
135 Úchytky  
135 Úchytky kované 001  
135 Úchytky kované 003  
135 Úchytky kované 004  
135 Úchytky Ulmen  
135 Úchytky Nurnberg

## DOPLŇKY

138 Balkónové kliky  
139 Kovaná posuvná klíka Steinacht  
140 Cylindrické vložky  
144 Číslice a piktogramy / klepadla  
146 Dorazy, stavěče, zarážky  
147 Řetízky, kukátka  
148 Držáky zábradlí  
148 Drobný spojovací materiál  
149 Krbové nářadí / Dětský program  
150 Panikové kování  
152 Rozety / montážní šablony  
153 Prahové lišty  
154 Samozavírače  
155 Větrací mřížky  
155 Vhozy na dopisy  
156 Věšáky a konzole  
158 Zadlabací zámky  
159 Závěsy  
164 Kování na sklo





**COBRA**<sup>®</sup> 

**Prodejna PRAHA**

Jeremiášova 2633/16b  
155 00 Praha 13 – Stodůlky

Pracovní doba:

Po-Čt: 8:00 – 18:00

Pá: 8:00 – 16:30

Tel.: +420 235 003 107

E-mail: prodejna@cobra-cz.cz



**[www.matekliku.cz](http://www.matekliku.cz)**  
[www.cobrask.sk](http://www.cobrask.sk)